



Front colours



No. 777 cosmos grey matt



No. 793 noble white matt



No. 722 polar white hgl.



Nr. 785 natural oak

F foiled front

carcass colours

* High gloss carcass for an additional price



No. 177
cosmos grey
matt

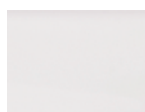

No. 111
white matt

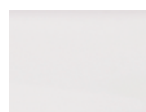

*no. 161
white hgl.



Nr. 185
natural oak

Washbasin plates and top covers colours

* High gloss plate against additional price



No. 177
cosmos grey matt



No. 111
white matt

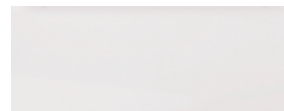

*no. 161
white hgl.



Nr. 185
natural oak



no. 170
Halifax oak



no. 174
Hunton oak

Washbasin colours

STONEPLUS washbasins



No. 61
white

STONEPLUS
STAINLESS STEEL

New, harder, easy-care surface.

Glass washbasin



no. 82
optiwhite



no. 92
optiwhite matt



no. 98
black matt

Ceramic counter top washbasin

Málaga



no. 1
white

Handle versions



No. 329
Strip handle chrome

handle length 194 mm / 294 mm
/ 494 mm



no. 338
Strip handle aluminium matt

handle length 194 mm / 294 mm
/ 494 mm



No. 339
Strip handle black matt

handle length 194 mm / 294 mm
/ 494 mm

Technique

door with integrated buffered closing









Pull outs and drawers

No. 554

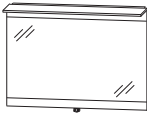
Illustrations and specifications are without obligation. Technical modifications reserved.
2022/2023 - ID







Please note the instruction for warranty, mounting and care, and the quality agreements as well, at the beginning of the book.

Program 070 - model list

Depth indication corresponds to the carcass depth		Depth in mm	Width in mm	Height in mm	Article number	Hinge	
Mirrors							
 	Mirror round all-round LED lighting 1 LED converter 30 W Emotion lighting Carrier material in white This product contains a light source with energy efficiency class: F						
	700 mm Ø 15,21 watt / 1338 lumens / 2700 - 6500 Kelvin 900 mm Ø 19,89 watt / 1750 lumens / 2700 - 6500 Kelvin	22	700	700	FSR407001		
 	Mirror 1 LED surface-mounted lamp in alu 1 LED converter Emotion lighting This product contains a light source with energy efficiency class: G Please state the carcass colour						
	634 mm wide 9,28 watt / Converter 15 watt 731 lumens / 2700 - 6500 Kelvin	123	634	668	SET416002		
	934 mm wide 14,08 watt / converter 30watt 1109 lumens / 2700 - 6500 Kelvin	123	934	668	SET419002		
	1234 mm wide 18,88 watt / converter 30watt 1487 lumens / 2700 - 6500 Kelvin	123	1234	668	SET411202		
	1434 mm wide 23,18 watt / converter 30watt 1739 lumens / 2700 - 6500 Kelvin	123	1434	668	SET411402		
 	Mirror LED aluminium frame all-round LED lighting 37,2 watt / converter 60 watt 3497 lumens / 2700 - 6500 Kelvin Emotion lighting This product contains a light source with energy efficiency class: F						
	aluminium frame in black matt anodize aluminium fram in white matt lacquered	40	600	640	FSB456004 FSB456005		
 	Mirror LED aluminium frame all-round LED lighting 46,5 watt / converter 60 watt 4371 lumens / 2700 - 6500 Kelvin Emotion lighting This product contains a light source with energy efficiency class: F						
	aluminium frame in black matt anodize aluminium fram in white matt lacquered	40	900	640	FSB459004 FSB459005		



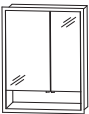



Please observe suitable accessories in the separate index.

Program 070 - model list

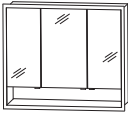
	Depth in mm	Width in mm	Height in mm	Article number	Hinge
<p>Depth indication corresponds to the carcass depth</p>					
<h2>Mirrors</h2>					
 <p>Mirror LED aluminium frame all-round LED lighting 55,8 watt / converter 60 watt 5245 lumens / 2700 - 6500 Kelvin Emotion lighting This product contains a light source with energy efficiency class: F</p>  <p>aluminium frame in black matt anodize</p> <p>aluminium fram in white matt lacquered</p>	<p>40</p> <p>40</p>	<p>1200</p> <p>1200</p>	<p>640</p> <p>640</p>	<p>F S B 4 5 1 2 0 4</p> <p>F S B 4 5 1 2 0 5</p>	
 <p>Mirror LED aluminium frame all-round LED lighting 52,0 watt / converter 60 watt 5980 lumens / 2700 - 6500 Kelvin Emotion lighting This product contains a light source with energy efficiency class: G</p>  <p>aluminium frame in black matt anodize</p> <p>aluminium fram in white matt lacquered</p>	<p>40</p> <p>40</p>	<p>1400</p> <p>1400</p>	<p>640</p> <p>640</p>	<p>F S B 4 5 1 4 0 4</p> <p>F S B 4 5 1 4 0 5</p>	
<h2>Built-in mirrored cabinet</h2>					
 <p>Built-in mirrored cabinet 2 double mirror doors 2 glass shelves LED aluminium frame 28,3 watt lateral overhang 25,5 mm with sensor for emotion lighting inkl. converter 60 Watt / 24 V. 1 switch socket element 1 illuminated shelf (2,64 watt) 1912 + 367 lumens / 2700 - 6500 Kelvin door height: 636 mm Door width: 396 mm / 196 mm This product contains a light source with energy efficiency class: G</p>  <p>III. = left incl. handle blocks</p> <p>Attention - important for wall cutout carcass depth= 600 mm carcass height: 800 mm</p> <p>wider door left</p> <p>wider door right</p>	<p>150</p> <p>150</p>	<p>651</p> <p>651</p>	<p>851</p> <p>851</p>	<p>S 2 A 5 5 6 L E 1</p> <p>S 2 A 5 5 6 R E 1</p>	

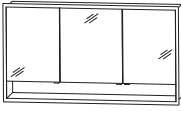

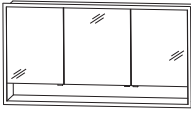



Please observe suitable accessories in the separate index.

Program 070 - model list

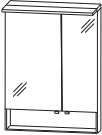
Depth indication corresponds to the carcass depth		Depth in mm	Width in mm	Height in mm	Article number	Hinge
 <p>Built-in mirrored cabinet 3 double mirror doors 2 central partitions, 6 glass shelves LED aluminium frame 34,1 watt lateral overhang 25,5 mm with sensor for emotion lighting inkl. converter 60 Watt / 24 V. 1 switch socket element 1 illuminated shelf (4,08 watt) 2300 + 587 lumens / 2700 - 6500 Kelvin door height: 636 mm Door width: 238 mm / 412 mm / 238 mm This product contains a light source with energy efficiency class: G Attention - important for wall cutout carcass depth= 900 mm carcass height: 800 mm</p>		150	951	851	S 2 A 5 5 9 0 E 1	
 incl. handle blocks						
 <p>Built-in mirrored cabinet 3 double mirror doors 2 central partitions, 6 glass shelves LED aluminium frame 39,8 watt lateral overhang 25,5 mm with sensor for emotion lighting inkl. converter 60 Watt / 24 V. 1 switch socket element 1 illuminated shelf (5,5 watt) 2689 + 807 lumens / 2700 - 6500 Kelvin door height: 636 mm Door width: 388 mm / 412 mm / 388 mm This product contains a light source with energy efficiency class: G Attention - important for wall cutout carcass depth= 1200 mm carcass height: 800 mm</p>		150	1251	851	S 2 A 5 5 1 2 E 1	
 incl. handle blocks						
 <p>Built-in mirrored cabinet 3 double mirror doors 2 central partitions, 6 glass shelves LED aluminium frame 43,7 watt lateral overhang 25,5 mm with sensor for emotion lighting inkl. converter 60 Watt / 24 V. 1 switch socket element 1 illuminated shelf (6,5 watt) 2948 + 954 lumens / 2700 - 6500 Kelvin door height: 636 mm Door width: 446 mm / 496 mm / 446 mm This product contains a light source with energy efficiency class: G Attention - important for wall cutout carcass depth= 1400 mm carcass height: 800 mm</p>		150	1451	851	S 2 A 5 5 1 4 E 1	
 incl. handle blocks						

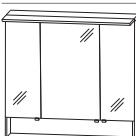
Also usable as top mirror cabinet
 Please observe suitable accessories in the separate index.

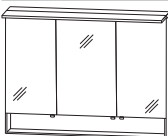





Program 070 - model list

Depth indication corresponds to the carcass depth		Depth in mm	Width in mm	Height in mm	Article number	Hinge
  III. = left incl. handle blocks		150	600	820	S 2 A 5 5 6 0 S 3	L/R
<p>mirror cabinet 2 double mirror doors 2 glass shelves 1 LED panel light (8,5 watt) 260 mm deep angled 1 illuminated shelf (2,64 watt) 699 + 328 lumens / (2700 -) 6500 Kelvin 1 LED converter 15 W 1 switch socket element door height: 636 mm Door width: 396 mm / 196 mm This product contains a light source with energy efficiency class: F</p> <p>Additional accessories LED washbasin lighting LED washbasin lighting emotion Emotion lighting</p>					P Z 1 0 6 3 6 0 P Z 1 1 5 0 6 0 P Z 1 0 2 0 1	
  incl. handle blocks		150	900	820	S 2 A 5 5 9 0 S 3	
<p>mirror cabinet 3 double mirror doors 2 central partitions, 6 glass shelves 1 LED panel light (13,2 watt) 260 mm deep angled 1 illuminated shelf (4,08 watt) 1082 + 506 lumens / (2700 -) 6500 Kelvin 1 LED converter 30 W 1 switch socket element door height: 636 mm Door width: 238 mm / 412 mm / 238 mm This product contains a light source with energy efficiency class: F</p> <p>Additional accessories LED washbasin lighting LED washbasin lighting emotion Emotion lighting</p>					P Z 1 0 6 3 9 0 P Z 1 1 5 0 9 0 P Z 1 0 2 0 1	
  incl. handle blocks		150	1200	820	S 2 A 5 5 1 2 S 3	
<p>mirror cabinet 3 double mirror doors 2 central partitions, 6 glass shelves 1 LED panel light (17,8 watt) 260 mm deep angled 1 illuminated shelf (5,5 watt) 1462 + 684 lumens / (2700 -) 6500 Kelvin 1 LED converter 30 W 1 switch socket element door height: 636 mm Door width: 388 mm / 412 mm / 388 mm This product contains a light source with energy efficiency class: F</p> <p>Additional accessories LED washbasin lighting LED washbasin lighting emotion Emotion lighting</p>					P Z 1 0 6 3 1 2 P Z 1 1 5 0 1 2 P Z 1 0 2 0 1	

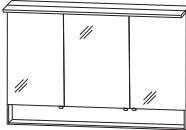
You find information on the the washbasin manufacturer at the beginning of the sales book.





***Delivery time: 8 weeks. Price per washbasin. Washbasin without tap hole is incompatible with CLOU System. Please check your order confirmation for correctness.**

Program 070 - model list

Depth indication corresponds to the carcass depth		Depth in mm	Width in mm	Height in mm	Article number	Hinge
Mirror cabinets						
  incl. handle blocks	mirror cabinet 3 double mirror doors 2 central partitions, 6 glass shelves 1 LED panel light (20,9 watt) 260 mm deep angled 1 illuminated shelf (6,5 watt) 1716 + 804 lumens / 2700 - 6500 Kelvin 1 LED converter 60 W with sensor for emotion lighting 1 switch socket element door height: 636 mm Door width: 446 mm / 496 mm / 446 mm This product contains a light source with energy efficiency class: F Additional accessories LED washbasin lighting LED washbasin lighting emotion	150	1400	820	S 2 A 5 5 1 4 S 3	
					P Z 1 0 6 3 12 P Z 1 1 5 0 12	
Washbasins						
 	washbasin 600 mm 1 tap hole incl. CLOU drain and overflow system can be combined with SET 2960 3M/B STONEPLUS - washbasin white Glass washbasin optiwhite Glass washbasin optiwhite matt Glass washbasin black matt Additional accessories Neutrally bonding silicone for glass washbasins Surcharge for washbasins without tap-hole or with 3 holes (according to sketch)	500	632	12	WMS 2 3 0 6 6 1 WGS 2 3 0 6 8 2 WGS 2 3 0 6 9 2 WGS 2 3 0 6 9 8	
					P Z 1 2 3 5	
 	washbasin 900 mm 1 tap hole incl. CLOU drain and overflow system can be combined with SET 2990 3M/B STONEPLUS - washbasin white Glass washbasin optiwhite Glass washbasin optiwhite matt Glass washbasin black matt Additional accessories Neutrally bonding silicone for glass washbasins Surcharge for washbasins without tap-hole or with 3 holes (according to sketch)	500	932	12	WMS 2 3 0 9 6 1 WGS 2 3 0 9 8 2 WGS 2 3 0 9 9 2 WGS 2 3 0 9 9 8	
					P Z 1 2 3 5	

You find information on the the washbasin manufacturer at the beginning of the sales book.
***Delivery time: 8 weeks. Price per washbasin. Washbasin without tap hole is incompatible with CLOU System. Please check your order confirmation for correctness.**

Program 070 - model list

Depth indication corresponds to the carcass depth		Depth in mm	Width in mm	Height in mm	Article number	Hinge
Washbasins						
	washbasin 1200 mm 1 tap hole incl. CLOU drain and overflow system can be combined with SET 2912 3M/B					
	STONEPLUS - washbasin white	500	1232	12	WMS 2 3 1 2 6 1	
	Glass washbasin optiwhite	500	1232	12	WGS 2 3 1 2 8 2	
	Glass washbasin optiwhite matt	500	1232	12	WGS 2 3 1 2 9 2	
	Glass washbasin black matt	500	1232	12	WGS 2 3 1 2 9 8	
	Additional accessories Neutrally bonding silicone for glass washbasins Surcharge for washbasins without tap-hole or with 3 holes (according to sketch)				P Z 1 2 3 5	
	Double washbasin 1400 mm 2 tap holes incl. 2 CLOU drain and overflow systems can be combined with SET 2914 3M/B					
	STONEPLUS - washbasin white	500	1432	12	WMS 2 3 4 D 6 1	
	Glass washbasin optiwhite	500	1432	12	WGS 2 3 4 D 8 2	
	Glass washbasin optiwhite matt	500	1432	12	WGS 2 3 4 D 9 2	
	Glass washbasin black matt	500	1432	12	WGS 2 3 4 D 9 8	
	Additional accessories Neutrally bonding silicone for glass washbasins Surcharge for washbasins without tap-hole or with 3 holes (according to sketch)				P Z 1 2 3 5	
Washbasin base units for washbasins						
	Washbasin base unit round for washbasins 1 metal pull out unit with buffered closing side doubling 10 mm each					
	without LED lighting	492	620	316	SET 2 9 6 0 3 M	
	with LED lighting 2,64 Watt / converter 15 Watt 211 lumens / 6000 Kelvin 1 motion sensor This product contains a light source with energy efficiency class: G	492	620	316	SET 2 9 6 0 3 B	
	for washbasins Additional accessories Design installationsset chrome: Space-producing drain stench trap DN 32				P Z 1 3 8 9 1E P Z 1 4 0 7	

You find information on the the washbasin manufacturer at the beginning of the sales book.



*Delivery time: 8 weeks. Price per washbasin. Washbasin without tap hole is incompatible with CLOU System. Please check your order confirmation for correctness.

Program 070 - model list

Depth indication corresponds to the carcass depth	Depth in mm	Width in mm	Height in mm	Article number	Hinge
<p>Washbasin base unit round for washbasins 1 metal pull out unit with buffered closing side doubling 10 mm each</p> <p>without LED lighting</p> <p>with LED lighting 2,64 Watt / converter 15 Watt 211 lumens / 6000 Kelvin 1 motion sensor This product contains a light source with energy efficiency class: G</p> <p>Additional accessories Design installationsset chrome: Space-producing drain stench trap DN 32</p>	492 492	920 920	316 316	<p>SET 2 9 9 0 3 M</p> <p>SET 2 9 9 0 3 B</p> <p>P Z 1 3 8 9 1 E P Z 1 4 0 7</p>	
<p>Washbasin base unit round for washbasins 1 metal pull out unit with buffered closing side doubling 10 mm each</p> <p>without LED lighting</p> <p>with LED lighting 2,64 Watt / converter 15 Watt 211 lumens / 6000 Kelvin 1 motion sensor This product contains a light source with energy efficiency class: G</p> <p>Additional accessories Design installationsset chrome: Space-producing drain stench trap DN 32</p>	492 492	1220 1220	316 316	<p>SET 2 9 1 2 3 M</p> <p>SET 2 9 1 2 3 B</p> <p>P Z 1 3 8 9 1 E P Z 1 4 0 7</p>	
<p>Washbasin base unit round for double washbasin solutions for washbasins 2 metal pull out units with buffered closing and syphon cut-out side doubling 10 mm each</p> <p>without LED lighting</p> <p>with LED lighting 2,64 Watt / converter 15 Watt 211 lumens / 6000 Kelvin 1 motion sensor This product contains a light source with energy efficiency class: G</p> <p>Additional accessories Design installationsset chrome (order 2 pieces) Space-producing drain stench trap DN 32 (order 2 pieces)</p>	492 492	1420 1420	316 316	<p>SET 2 9 1 4 3 M</p> <p>SET 2 9 1 4 3 B</p> <p>P Z 1 3 8 9 1 E P Z 1 4 0 7</p>	

You find information on the the washbasin manufacturer at the beginning of the sales book.
Please observe suitable accessories in the separate index.

Program 070 - model list

Depth indication corresponds to the carcass depth		Depth in mm	Width in mm	Height in mm	Article number	Hinge
Ceramic counter top washbasin						
	ceramic counter too Málaga white incl. tap hole with overflow Matching washstand cutout	420	550	95	W T A 4 2 5 5 1 A U S 4 2 5 5 2 8	
Washbasin plates						
	washbasin plate with ABS edge Width 626 mm for 1 cutout central Width 926 mm for 1 cutout central Width 1226 mm for 1 cutout central Width 1426 mm for 2 cutouts left and right Please note the additional price for washbasin cutouts.	495	626	28	A P A 5 0 6 0 6 3 A P A 5 0 9 0 6 3 A P A 5 0 1 2 6 3 A P A 5 0 1 4 6 3	
Washbasin base units for counter top washbasins and washbasin plates						
	Washbasin base unit round for counter top washbasins at washbasin plates 1 metal pull out unit with buffered closing side doubling 10 mm each without LED lighting with LED lighting 2,64 Watt / converter 15 Watt 211 lumens / 6000 Kelvin 1 motion sensor This product contains a light source with energy efficiency class: G Additional accessories Design installationsset chrome: Space-producing drain stench trap DN 32	492	620	316	S E T 2 9 6 0 2 M S E T 2 9 6 0 2 B P Z 1 3 8 9 1 E P Z 1 4 0 7	

You find information on the the washbasin manufacturer at the beginning of the sales book.
Please observe suitable accessories in the separate index.

Program 070 - model list

Depth indication corresponds to the carcass depth	Depth in mm	Width in mm	Height in mm	Article number	Hinge
<p>Washbasin base unit round for counter top washbasins at washbasin plates 1 metal pull out unit with buffered closing side doubling 10 mm each</p> <p>without LED lighting with LED lighting 2,64 Watt / converter 15 Watt 211 lumens / 6000 Kelvin 1 motion sensor This product contains a light source with energy efficiency class: G</p> <p>Additional accessories Design installationsset chrome: Space-producing drain stench trap DN 32</p>	<p>492</p> <p>492</p>	<p>920</p> <p>920</p>	<p>316</p> <p>316</p>	<p>SET 2 9 9 0 2 M SET 2 9 9 0 2 B</p> <p>P Z 1 3 8 9 1 E P Z 1 4 0 7</p>	
<p>Washbasin base unit round for counter top washbasins at washbasin plates 1 metal pull out unit with buffered closing side doubling 10 mm each</p> <p>without LED lighting with LED lighting 2,64 Watt / converter 15 Watt 211 lumens / 6000 Kelvin 1 motion sensor This product contains a light source with energy efficiency class: G</p> <p>Additional accessories Design installationsset chrome: Space-producing drain stench trap DN 32</p>	<p>492</p> <p>492</p>	<p>1220</p> <p>1220</p>	<p>316</p> <p>316</p>	<p>SET 2 9 1 2 2 M SET 2 9 1 2 2 B</p> <p>P Z 1 3 8 9 1 E P Z 1 4 0 7</p>	
<p>Washbasin base unit round for double washbasin solutions for counter top washbasins at washbasin plates 2 metal pull out units with buffered closing and syphon cut-out side doubling 10 mm each</p> <p>without LED lighting with LED lighting 2,64 Watt / converter 15 Watt 211 lumens / 6000 Kelvin 1 motion sensor This product contains a light source with energy efficiency class: G</p> <p>Additional accessories Design installationsset chrome (order 2 pieces) Space-producing drain stench trap DN 32 (order 2 pieces)</p>	<p>492</p> <p>492</p>	<p>1420</p> <p>1420</p>	<p>316</p> <p>316</p>	<p>SET 2 9 1 4 2 M SET 2 9 1 4 2 B</p> <p>P Z 1 3 8 9 1 E P Z 1 4 0 7</p>	

Please observe suitable accessories in the separate index.

Program 070 - model list

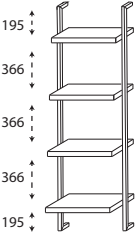
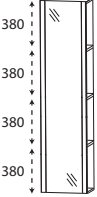
Depth indication corresponds to the carcass depth	Depth in mm	Width in mm	Height in mm	Article number	Hinge
<h2>Counter tops</h2>  <p>top cover for assembling underneath the washbasin base unit</p> <p>Please position the drillings of brackets depending on the water supply line.</p> <p>620 mm wide incl. 2 wall fixings</p> <p>920 mm wide incl. 2 wall fixings</p> <p>1220 mm wide incl. 3 wall fixings</p> <p>1420 mm wide incl. 3 wall fixings</p>					
<h2>System shelf</h2>  <p>System shelf metal frame in black matt 4 fixed wooden shelves Depth: 200 mm, 240 mm, 280 mm, 320 mm variable in width</p> <p>Width from both outer edges of the frame</p>	320	300-600	1600	RGM160V01	
<h2>Tall unit-shelf</h2>  <p>Tall unit-shelf 1 door with mirror surface 3 fixed wooden shelves in carcass colour</p> <p>Ill. = left</p>	150	400	1600	HOG104001	L/R

Please observe suitable accessories in the separate index.

Program 070 - model list

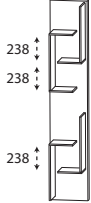
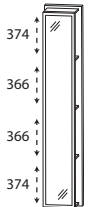
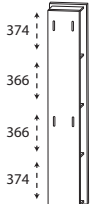
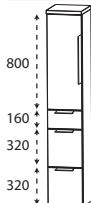
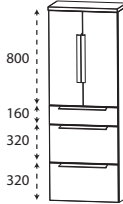
Depth indication corresponds to the carcass depth		Depth in mm	Width in mm	Height in mm	Article number			Hinge
Tall unit-shelf								
	Tall unit-shelf with open shelf space in carcass colour	150	300	1600	R G	1 0 3 0 0 1		
	Tall unit-shelf with mirror surface 4 shelves compartments in carcass colour	150	300	1600	R G	1 0 3 0 0 2		
	Tall unit-shelf 4 functional hooks 4 shelves compartments in carcass colour	150	300	1600	R G	1 0 3 0 0 3		
Tall units								
	Tall unit 1 door 2 glass shelves (top) 2 metal pull-outs with buffered closing 1 drawer with buffered closing 1 top cover 330 mm deep	300 300	300 400	1628 1628	H N A	0 9 3 A 7 M 0 9 4 A 7 M	L/R L/R	
	Tall unit 2 doors 2 glass shelves (top) 2 metal pull-outs with buffered closing 1 drawer with buffered closing 1 top cover 330 mm deep	300	600	1628	H N A	0 9 6 A 7 M		

Program 070 - model list

Depth indication corresponds to the carcass depth

Tall units

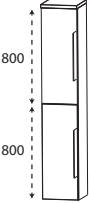
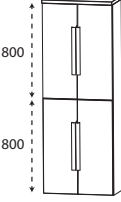
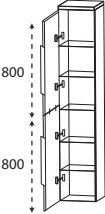
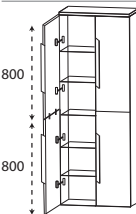
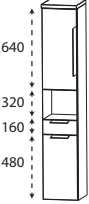
	Depth in mm	Width in mm	Height in mm	Article number	Hinge
 <p>Tall unit 2 doors 2 glass shelves (top) 2 adjustable shelves (bottom) 1 top cover 330 mm deep</p>	300	300	1628	H N A 0 3 3 A	7 L/R
	300	400	1628	H N A 0 3 4 A	7 L/R
	150-299	300	1628	H V A 0 3 3 0	L/R
	150-299	400	1628	H V A 0 3 4 0	L/R
 <p>Tall unit 4 doors 2 glass shelves (top) 2 adjustable shelves (bottom) 1 top cover 330 mm deep</p>	300	600	1628	H N A 0 3 6 A	7
	150-299	600	1628	H V A 0 3 6 0	
 <p>Tall unit for brooms 2 strapped doors 5 glass shelves 1 top cover 330 mm deep</p>	300	300	1628	H N A 0 3 3 A 7 1	L/R
	300	400	1628	H N A 0 3 4 A 7 1	L/R
 <p>Tall unit for brooms 2 strapped doors left 2 strapped doors right 5 continuously glass shelves 1 top cover 330 mm deep</p>	300	600	1628	H N A 0 3 6 A 7 1	
 <p>Tall unit 1 door 1 glass shelf (top) 1 open compartment 1 drawer with buffered closing 1 door 1 glass shelf 1 top cover 330 mm deep</p>	300	300	1628	H N A 0 2 3 A 7 1	L/R
	300	400	1628	H N A 0 2 4 A 7 1	L/R

Please observe suitable accessories in the separate index.

Program 070 - model list

Depth indication corresponds to the carcass depth

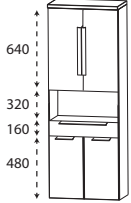
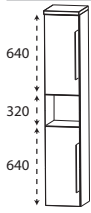
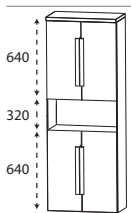
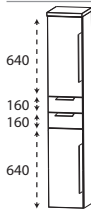
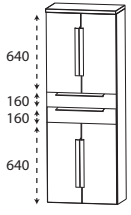
	Depth in mm	Width in mm	Height in mm	Article number	Hinge
 <p>Tall unit 2 doors 1 glass shelf (top) 1 open compartment 1 drawer with buffered closing 2 doors 1 glass shelf 1 top cover 330 mm deep</p>	300	600	1628	HNA026A71	
 <p>Tall unit 1 door 1 glass shelf (top) 1 open compartment 1 door 1 glass shelf 1 top cover 330 mm deep</p>	300 300	300 400	1628 1628	HNA023A72 HNA024A72	L/R L/R
 <p>Tall unit 2 doors 1 glass shelf (top) 1 open compartment 2 doors 1 glass shelf 1 top cover 330 mm deep</p>	300	600	1628	HNA026A72	
 <p>Tall unit 1 door 1 glass shelf (top) 2 metal pull-outs with buffered closing, 1 door 1 glass shelf 1 top cover 330 mm deep</p>	300 300	300 400	1628 1628	HNA043A71 HNA044A71	L/R L/R
 <p>Tall unit 2 doors 1 glass shelf (top) 2 metal pull-outs with buffered closing, 2 doors 1 glass shelf 1 top cover 330 mm deep</p>	300	600	1628	HNA046A71	

Please observe suitable accessories in the separate index.

Program 070 - model list

Depth indication corresponds to the carcass depth

Tall units

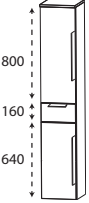
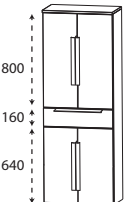
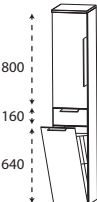
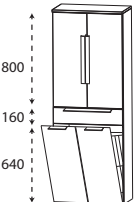
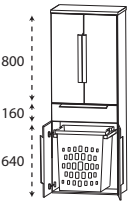
	Depth in mm	Width in mm	Height in mm	Article number	Hinge
 <p>800 160 640</p>	300	300	1628	HNA053A7M	L/R
	300	400	1628	HNA054A7M	L/R
 <p>800 160 640</p>	300	600	1628	HNA056A7M	
 <p>800 160 640</p>	300	300	1628	HNA053A7W	L/R
	300	400	1628	HNA054A7W	L/R
 <p>800 160 640</p>	300	600	1628	HNA056A7W	
 <p>800 160 640</p>	300	600	1628	HNA056A1W	

Please observe suitable accessories in the separate index.

Program 070 - model list

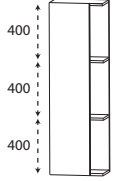
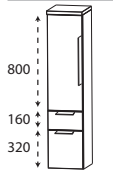
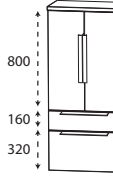
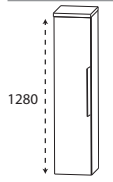
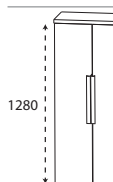
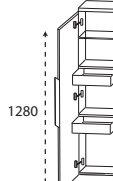
	Depth in mm	Width in mm	Height in mm	Article number	Hinge
Depth indication corresponds to the carcass depth					
medium-high unit-shelf					
 <p>III. = left</p>	150	400	1280	MOG 8 1 4 0 0 1	L/R
<p>medium-high unit 1 door in carcass colour 300 mm wide 2 fixed wooden shelves in carcass colour</p>					
Central units					
	300	300	1308	MNA 8 8 3 A 7 M	L/R
	300	400	1308	MNA 8 8 4 A 7 M	L/R
<p>medium-high unit 1 door 2 glass shelves (top) 1 metal pull-out with buffered closing, 1 drawer with buffered closing 1 top cover 330 mm deep</p>					
	300	600	1308	MNA 8 8 6 A 7 M	
<p>medium-high unit 2 doors 2 glass shelves (top) 1 metal pull-out with buffered closing, 1 drawer with buffered closing 1 top cover 330 mm deep</p>					
	300	300	1308	MNA 8 1 3 A 7	L/R
	300	400	1308	MNA 8 1 4 A 7	L/R
	150-299	300	1308	MVA 8 1 3 0	L/R
	150-299	400	1308	MVA 8 1 4 0	L/R
<p>Variable in width: please quote the exact dimension of carcass depth. Top cover will be adapted to the cupboard width.</p>					
	300	600	1308	MNA 8 1 6 A 7	
<p>medium-high unit 2 doors 4 glass shelves 1 top cover 330 mm deep</p>					
<p>Variable in width: please quote the exact dimension of carcass depth. Top cover will be adapted to the cupboard width.</p>					
	300	300	1308	MNA 8 4 3 A 7	L/R
	300	400	1308	MNA 8 4 4 A 7	L/R
<p>medium-high unit with inside drawers 1 door 2 inside metal-drawer with buffered closing 1 glass shelf 1 top cover 330 mm deep</p>					

Please observe suitable accessories in the separate index.

Program 070 - model list

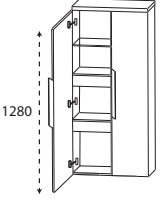
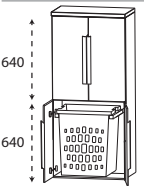
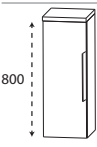
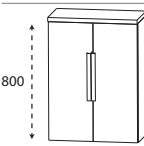
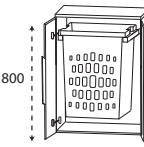
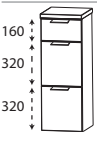
Depth indication corresponds to the carcass depth		Depth in mm	Width in mm	Height in mm	Article number		Hinge
Central units							
	medium-high unit with inside drawers 2 doors 2 continuously inside metal-drawer with buffered closing 1 glass shelf 1 top cover 330 mm deep	300	600	1308	M N A 8 4 6 A	7	
	medium-high unit with laundry pull out 2 doors 1 glass shelf (top) 2 doors 1 laundry pull out with wire basket Volume of laundry pull out: 40 liters 1 top cover 330 mm deep	300	600	1308	M N A 8 3 6 A	1 W	
Highboards							
	Highboard 1 door 2 glass shelves 1 top cover 330 mm deep	300	300	828	H B A 5 1 3 A	7	L/R
		300	400	828	H B A 5 1 4 A	7	L/R
	Variable in width: please quote the exact dimension of carcass depth. Top cover will be adapted to the cupboard width.	150-299	300	828	H B V A 5 1 3		L/R
		150-299	400	828	H B V A 5 1 4		L/R
	Highboard 2 doors 2 glass shelves 1 top cover 330 mm deep	300	600	828	H B A 5 1 6 A	7	
	Variable in width: please quote the exact dimension of carcass depth. Top cover will be adapted to the cupboard width.	150-299	600	828	H B V A 5 1 6		
	Highboard with laundry pull out 2 doors 1 laundry pull out with wire basket 1 top cover 330 mm deep Volume of laundry pull out: 40 liters	300	600	828	H B A 5 1 6 A	1 W	
	Highboard 1 drawer with buffered closing 2 metal pull-outs with buffered closing 1 top cover 330 mm deep	300	300	828	H B A 5 6 3 A	7 M	
		300	400	828	H B A 5 6 4 A	7 M	

Please observe suitable accessories in the separate index.

Program 070 - model list

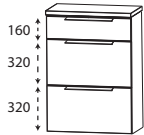
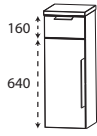
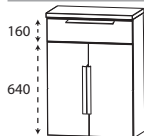
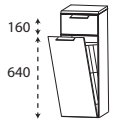
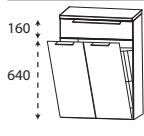
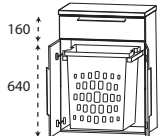
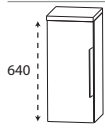
Depth indication corresponds to the carcass depth		Depth in mm	Width in mm	Height in mm	Article number	Hinge
Highboards						
	Highboard 1 drawer with buffered closing 2 metal pull-outs with buffered closing 1 top cover 330 mm deep	300	600	828	H B A 5 5 6 6 A 7 M	
	1 drawer with buffered closing 1 door 1 glass shelf 1 top cover 330 mm deep	300	300	828	H B A 5 5 3 A 7 M	L/R
		300	400	828	H B A 5 5 4 A 7 M	L/R
	Highboard 1 drawer with buffered closing 2 doors 1 glass shelf 1 top cover 330 mm deep	300	600	828	H B A 5 5 6 A 7 M	
	Highboard with laundry basket 1 drawer with buffered closing 1 laundry basket with wire basket 1 top cover 330 mm deep Volume of laundry basket: 25 liters Volume of laundry basket: 35 liters	300	300	828	H B A 5 5 3 A 7 W	
		300	400	828	H B A 5 5 4 A 7 W	
	Highboard with laundry basket 1 drawer with buffered closing 1 laundry basket with wire basket 1 top cover 330 mm deep Volume of laundry basket: 55 liters	300	600	828	H B A 5 5 6 A 7 W	
	Highboard with laundry pull out 1 drawer with buffered closing 2 doors 1 laundry pull out with wire basket 1 top cover 330 mm deep Volume of laundry pull out: 40 liters	300	600	828	H B A 5 5 6 A 1 W	
Wall units						
	Wall unit 1 door 1 glass shelf 1 top cover 180 mm deep Variable in width: please quote the exact dimension of carcass depth. Top cover will be adapted to the cupboard width.	150	300	668	O G A 4 1 3 A	7 L/R
		150	400	668	O G A 4 1 4 A	7 L/R
		151-300	300	668	O V A 4 1 3 0	L/R
		151-300	400	668	O V A 4 1 4 0	L/R





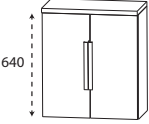
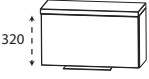
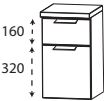
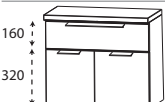
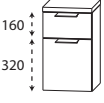
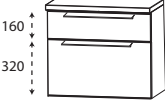
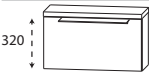

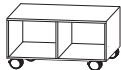

Please observe suitable accessories in the separate index.

Program 070 - model list

Depth indication corresponds to the carcass depth		Depth in mm	Width in mm	Height in mm	Article number	Hinge
Wall units						
	Wall unit 2 doors 1 glass shelf 1 top cover 180 mm deep	150	600	668	O G A 4 1 6 A 7	
	Variable in width: please quote the exact dimension of carcass depth. Top cover will be adapted to the cupboard width.	151-300	600	668	O V A 4 1 6 0	
	Wall unit 1 flap door, 1 top cover 260 mm deep	230	600	348	O M A 2 1 6 A 7 K	
Base units						
	Base unit 1 drawer with buffered closing 1 door 1 top cover 330 mm deep	300	300	508	U N A 3 2 3 A 7 M	L/R
			300	400	508	U N A 3 2 4 A 7 M
	Base unit 1 drawer with buffered closing 2 doors 1 top cover 330 mm deep	300	600	508	U N A 3 2 6 A 7 M	
	Base unit 1 drawer with buffered closing 1 metal pull-out with buffered closing, 1 top cover 330 mm deep	300	300	508	U N A 3 4 3 A 7 M	
			300	400	508	U N A 3 4 4 A 7 M
	Base unit 1 drawer with buffered closing 1 metal pull-out with buffered closing, 1 top cover 330 mm deep	300	600	508	U N A 3 4 6 A 7 M	
	Base unit 1 flap door, 1 top cover 260 mm deep	230	600	348	U M A 2 1 6 A 7 K	



Please observe suitable accessories in the separate index.

Program 070 - model list

Depth indication corresponds to the carcass depth		Depth in mm	Width in mm	Height in mm	Article number	Hinge
Trolleys						
	Trolley 2 compartments compartments widths: 275 mm 4 roles incl. height indication rolls (100 mm)	400	600	340	ROW 1 1 6 0 0 2	
	Trolley 3 compartments compartments widths: 278 mm 5 roles incl. height indication rolls (100 mm)	400	900	340	ROW 1 1 9 0 0 3	
	Trolley 4 compartments compartments widths: 278 mm 5 roles incl. height indication rolls (100 mm)	400	1200	340	ROW 1 1 1 2 0 4	
	Trolley 5 compartments compartments widths: 278 mm 5 roles incl. height indication rolls (100 mm)	400	1400	340	ROW 1 1 1 4 0 5	
	Storage box gris foldable 1 Eingrifföse	255	255	200	P Z 1 1 5 3 0 1	
Shelves						
	functional shelf Edges are cut with a mitre vertical and horizontal mounting possible please indicate colour version: no. 501 white matt lacquered no. 547 black matt lacquered	150	300	160	R G L 1 1 3 0 0 1	
	functional shelf Edges are cut with a mitre vertical and horizontal mounting possible please indicate colour version: no. 501 white matt lacquered no. 547 black matt lacquered	150	600	160	R G L 1 1 6 0 0 2	
	functional shelf Edges are cut with a mitre vertical and horizontal mounting possible please indicate colour version: no. 501 white matt lacquered no. 547 black matt lacquered	150	900	160	R G L 1 1 9 0 0 3	

Please observe suitable accessories in the separate index.

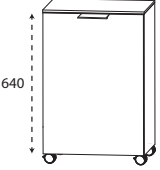
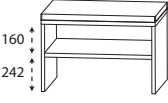
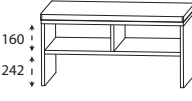
Program 070 - model list

	Depth in mm	Width in mm	Height in mm	Article number	Hinge
Depth indication corresponds to the carcass depth					
Laundryrolli					
	470	470	756	WRS 4 0 4 7	
<p>Laundryrolli 1 flap door, with buffered closing 1 take-out laundry-bag, washable 4 roles Colour version corresponds to the carcass colour incl. height indication rolls (100 mm)</p>					
Benches					
					
<p>Bench 1 shelf 1 seat cushion in imitation leather Colour version corresponds to the carcass colour</p>					
cushion in creamy-white	450	600	508	SETBANK 6 W	
cushion in black	450	600	508	SETBANK 6 S	
					
<p>Bench 2 shelves 1 seat cushion in imitation leather Colour version corresponds to the carcass colour</p>					
cushion in creamy-white	450	900	508	SETBANK 9 W	
cushion in black	450	900	508	SETBANK 9 S	
Glass shelves					
					
<p>Glass shelf incl. metal holder</p>					
400 mm wide incl. 2 metal brackets	130	400	8	ABG 1 3 4 0 0 8	
600 mm wide incl. 2 metal brackets	130	600	8	ABG 1 3 6 0 0 8	
900 mm wide incl. 3 metal brackets	130	900	8	ABG 1 3 9 0 0 8	
1200 mm wide incl. 3 metal brackets	130	1200	8	ABG 1 3 1 2 0 8	
1400 mm wide incl. 4 metal brackets	130	1400	8	ABG 1 3 1 4 0 8	

Please observe suitable accessories in the separate index.

Program 070 - bathroom variations

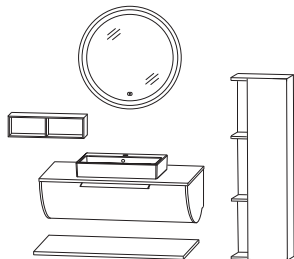
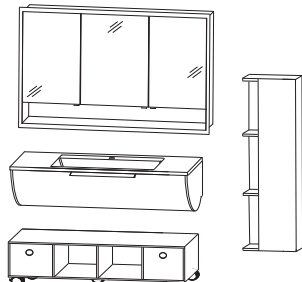
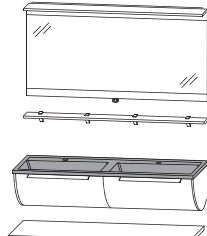
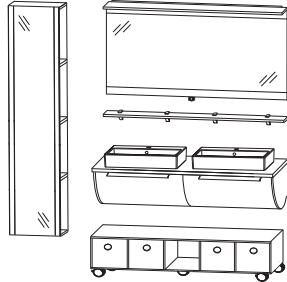
ROK-0190-1		
1 Mirror round 1 Ceramic counter top washbasin 1 washbasin plate 1 cut- out central 1 Washbasin base unit 1 top cover 1 functional shelf in white matt 1 medium-high unit	F S R 4 0 7 0 0 1 W T A 4 2 5 5 1 A P A 5 0 9 0 6 3 A U S 4 2 5 5 2 8 S E T 2 9 9 0 2 M A U W 4 0 9 2 2 8 R G L 1 1 6 0 0 2 M O G 8 1 4 0 0 1	
		926 mm wide
ROS-6112-1		
1 Built-in mirrored cabinet 1 STONEPLUS - washbasin 1 Washbasin base unit with LED lighting 1 Trolley 2 Storage box 1 medium-high unit	S 2 A 5 5 1 2 E 1 W M S 2 3 1 2 6 1 S E T 2 9 1 2 3 B R O W 1 1 1 2 0 4 P Z 1 1 5 3 0 1 M O G 8 1 4 0 0 1	
		1232 mm wide
ROG-9814-1D		
1 Mirror 1 Glass shelf 1 glass washbasin in black matt 1 Washbasin base unit with LED lighting 1 top cover	S E T 4 1 1 4 0 2 A B G 1 3 1 4 0 8 W G S 2 3 4 D 9 8 S E T 2 9 1 4 3 B A U W 4 0 1 4 2 8	
		1432 mm wide
ROK-0114-1D		
1 Mirror 1 Glass shelf 2 Ceramic counter top washbasin 2 cut- out left and right 1 washbasin plate 1 Washbasin base unit with LED lighting 1 Trolley 4 Storage box 1 Tall unit-shelf	S E T 4 1 1 4 0 2 A B G 1 3 1 4 0 8 W T A 4 2 5 5 1 A U S 4 2 5 5 2 8 A P A 5 0 1 4 6 3 S E T 2 9 1 4 2 B R O W 1 1 1 4 0 5 P Z 1 1 5 3 0 1 H O G 1 0 4 0 0 1	
		1426 mm wide

Program 070 - dimensional drawings

WMS/WGS 2306 + SET 2960 3x

WMS/WGS 2309 + SET 2990 3x

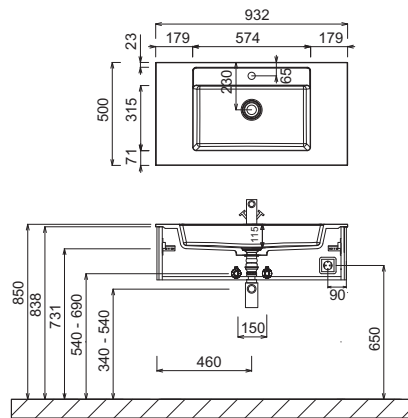
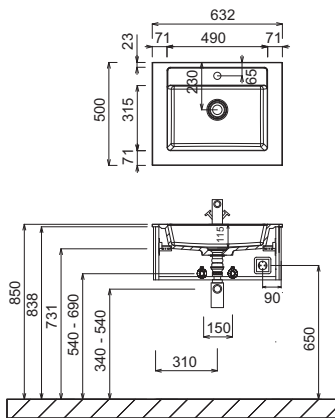

WMS/WGS 2312 + SET 2912 3x

WMS/WGS 234D + SET 2914 3x

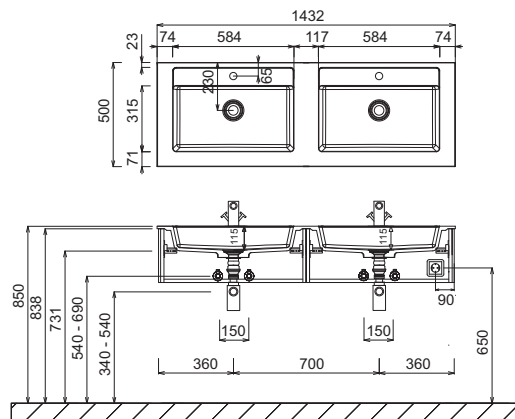
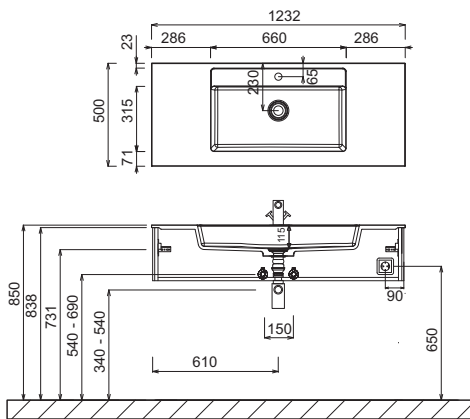

WTA 4255 1 + APA 5060 63 + SET 2960 2x

WTA 4255 1 + APA 5090 63 + SET 2990 2x

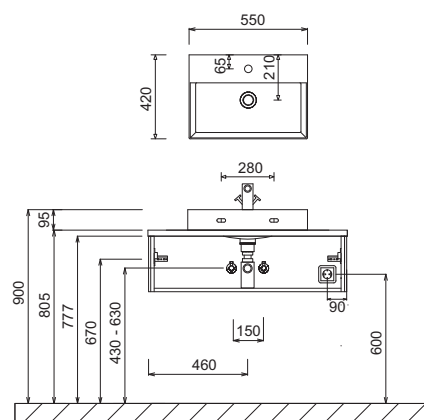
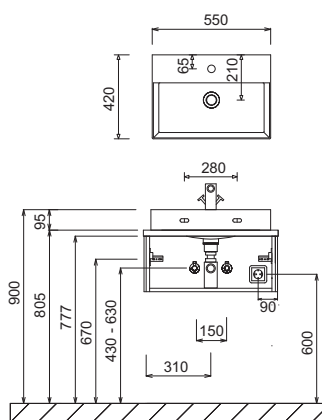

Washing stands without anchoring brackets have to be fixed on the wall and on the furniture-side with silicon!

STONEPLUS:

The water temperature must not exceed 55° C / 131° F. Hair tinting lotions have to be removed in a few seconds, so that staining can be avoided.

Modifications:

Technical modifications (+/- 5mm) and flatness modifications (DIN 18202) are subject of the usual material-specific modifications for construction materials, based on DIN 18202.

Program 070 - dimensional drawings

WTA 4255 1 + APA 5012 63 + SET 2912 2x

2x WTA 4255 1 + APA 5014 63 + SET 2914 2x

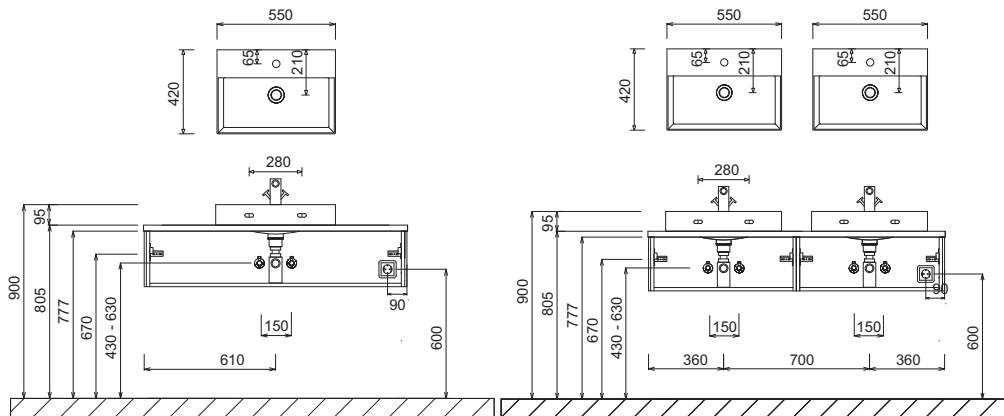

electrical connections for mirror cabinets

Built-in mirrored cabinet

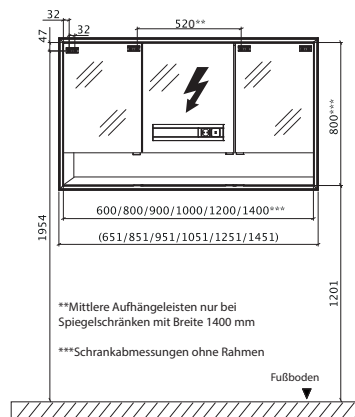
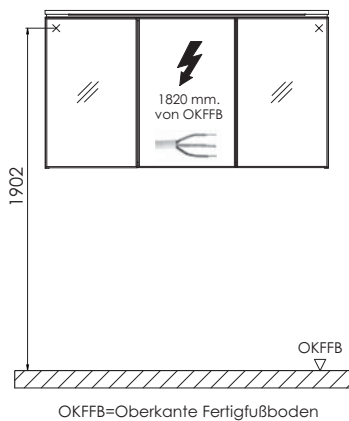

Wall cutout for built-in mirrored cabinets

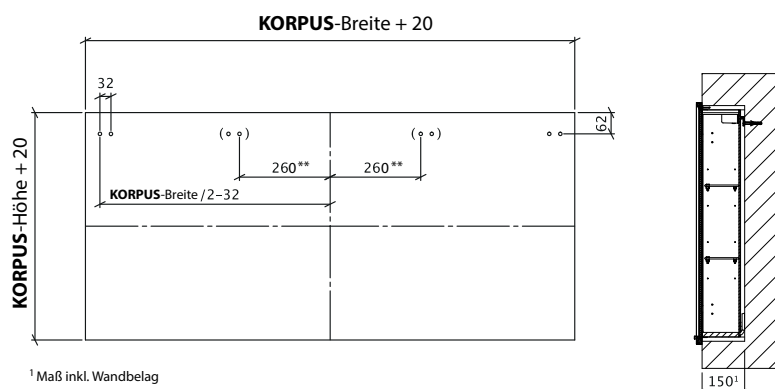

¹ Maß inkl. Wandbelag

**Mittlere Aufhängeleisten nur bei Spiegelschränken mit Breite 1400 mm

Washing stands without anchoring brackets have to be fixed on the wall and on the furniture-side with silicon!

STONEPLUS:

The water temperature must not exceed 55° C / 131° F. Hair tinting lotions have to be removed in a few seconds, so that staining can be avoided.

Modifications:

Technical modifications (+/- 5mm) and flatness modifications (DIN 18202) are subject of the usual material-specific modifications for construction materials, based on DIN 18202.