



## Front colours



No. 777 cosmos grey matt



No. 891 quarz grey matt

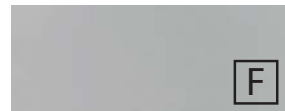

No. 893 titanium grey matt



No. 793 noble white matt



No. 722 polar white hgl.



no. 670 Halifax oak



No. 750 cardiff oak



no. 751 Cuneo oak brown



no. 771 Cuneo oak natural

**F** foiled front

**M** Melamine coated front with ABS-edge

## carcass colours

\* High gloss carcass for an additional price



No. 177  
cosmos grey matt



no. 191  
quarz grey matt



No. 193  
titanium grey  
matt



No. 111  
white matt



\*no. 161  
white hgl.



no. 170  
Halifax oak



no. 150  
cardiff oak



no. 151  
Cuneo oak brown



no. 171 Cuneo  
oak natural

## Washbasin colours

STONEPLUS washbasin



No. 61  
white

STONEPLUS®

Glass washbasin



no. 82  
optiwhite



no. 92  
optiwhite matt

## Handle versions



No. 351 strip handle alu  
matt



No. 352 strip handle black  
matt

## Technique

door with integrated buffered closing







Pull outs and drawers

No. 554

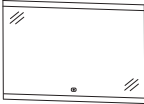
Illustrations and specifications are without obligation. Technical modifications reserved.  
2022/2023 - ID

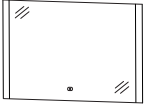





Please note the instruction for warranty, mounting and care, and the quality agreements as well, at the beginning of the book.

# Program 072 - model list

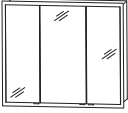
Depth indication corresponds to the carcass depth		Depth in mm	Width in mm	Height in mm	Article number	Hinge
<b>Mirrors</b>						
 	<b>Mirror</b> LED acrylic strips at top and bottom Emotion lighting 1 LED converter This product contains a light source with energy efficiency class: F					
	<b>600 mm wide</b> 17,1 watt / 1607 lumens / 2700 - 6500 Kelvin	28	600	640	<b>F S B 4 3 6 0 0 1</b>	
	<b>900 mm wide</b> 26,4 watt / 2482 lumens / 2700 - 6500 Kelvin	28	900	640	<b>F S B 4 3 9 0 0 1</b>	
	<b>1200 mm wide</b> 35,7 watt / 3356 lumens / 2700 - 6500 Kelvin	28	1200	640	<b>F S B 4 3 1 2 0 1</b>	
	<b>1400 mm wide</b> 41,9 watt / 3939 lumens / 2700 - 6500 Kelvin	28	1400	640	<b>F S B 4 3 1 4 0 1</b>	
 	<b>Mirror</b> LED acrylic strips left and right Emotion lighting 18,6 watt / converter 30watt 1748 lumens / 2700 - 6500 Kelvin This product contains a light source with energy efficiency class: F					
	<b>600 mm wide</b>	28	600	640	<b>F S B 4 4 6 0 0 2</b>	
	<b>900 mm wide</b>	28	900	640	<b>F S B 4 4 9 0 0 2</b>	
	<b>1200 mm wide</b>	28	1200	640	<b>F S B 4 4 1 2 0 2</b>	
	<b>1400 mm wide</b>	28	1400	640	<b>F S B 4 4 1 4 0 2</b>	
<b>Built-in mirrored cabinet</b>						
  <p>incl. handle blocks</p>	<b>Built-in mirrored cabinet</b> 2 double mirror doors 2 glass shelves LED aluminium frame 28,3 watt 1912 lumens / 2700 - 6500 Kelvin lateral overhang 25,5 mm with sensor for emotion lighting inkl. converter 60 Watt / 24 V. 1 switch socket element Door width: 296 mm / 296 mm This product contains a light source with energy efficiency class: G <b>Attention - important for wall cutout</b> carcass width: 600 mm carcass height: 800 mm	150	651	851	<b>S 2 A 5 3 6 0 E 1</b>	

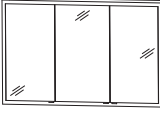

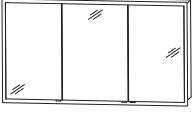



Please observe suitable accessories in the separate index.

# Program 072 - model list

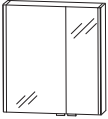
Depth indication corresponds to the carcass depth		Depth in mm	Width in mm	Height in mm	Article number	Hinge
 <p><b>Built-in mirrored cabinet</b>            3 double mirror doors            6 glass shelves            2 central partitions,            LED aluminium frame 34,1 watt            2300 lumens / 2700 - 6500 Kelvin            lateral overhang 25,5 mm            with sensor for emotion lighting            inkl. converter 60 Watt / 24 V.            1 switch socket element            Door width: 238 mm / 412 mm / 238 mm            This product contains a light source with energy efficiency class: G  <b>Attention - important for wall cutout</b>            carcass depth= 900 mm            carcass height: 800 mm</p>		150	951	851	S 2 A 5 3 9 0 E 1	
 <p>incl. handle blocks</p>						
 <p><b>Built-in mirrored cabinet</b>            3 double mirror doors            6 glass shelves            2 central partitions,            LED aluminium frame 39,8 watt            2689 lumens / 2700 - 6500 Kelvin            lateral overhang 25,5 mm            with sensor for emotion lighting            inkl. converter 60 Watt / 24 V.            1 switch socket element            Door width: 388 mm / 412 mm / 388 mm            This product contains a light source with energy efficiency class: G  <b>Attention - important for wall cutout</b>            carcass depth= 1200 mm            carcass height: 800 mm</p>		150	1251	851	S 2 A 5 3 1 2 E 1	
 <p>incl. handle blocks</p>						
 <p><b>Built-in mirrored cabinet</b>            3 double mirror doors            6 glass shelves            2 central partitions,            LED aluminium frame 43,7 watt            2948 lumens / 2700 - 6500 Kelvin            lateral overhang 25,5 mm            with sensor for emotion lighting            inkl. converter 60 Watt / 24 V.            1 switch socket element            Door width: 446 mm / 496 mm / 446 mm            This product contains a light source with energy efficiency class: G  <b>Attention - important for wall cutout</b>            carcass depth= 1400 mm            carcass height: 800 mm</p>		150	1451	851	S 2 A 5 3 1 4 E 1	
 <p>incl. handle blocks</p>						

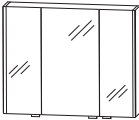

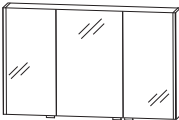



Also usable as top mirror cabinet  
 Please observe suitable accessories in the separate index.

# Program 072 - model list

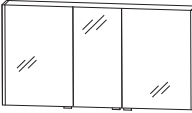
		Depth in mm	Width in mm	Height in mm	Article number			
Depth indication corresponds to the carcass depth								
<b>Mirror cabinets</b>								
	<b>mirror cabinet</b> 2 double mirror doors with 2 side panel lights 9,7 watt each 2 x 910 lumens / 2700 - 6500 Kelvin left and right 2 glass shelves 1 LED converter 60 W with sensor for emotion lighting 1 switch-socket element Door width: 396 mm / 196 mm This product contains a light source with energy efficiency class: F							
	III. = left incl. handle blocks							
	<b>wider door left</b>	150	620	640	<b>S 2 A 4 4 6 L 0 7</b>			
	<b>wider door right</b>	150	620	640	<b>S 2 A 4 4 6 R 0 7</b>			
	Additional accessories LED washbasin lighting LED washbasin lighting emotion LED lighting element 634 mm wide in matt chrome LED lighting element 634 mm wide in black matt				PZ 1 0 6 3 60 PZ 1 1 5 0 60 PZ 1 1 4 0 60 PZ 1 1 6 0 60			
	<b>mirror cabinet</b> 3 double mirror doors with 2 side panel lights 9,7 watt each 2 x 910 lumens / 2700 - 6500 Kelvin left and right 2 central partitions, 6 glass shelves 1 LED converter 60 W with sensor for emotion lighting 1 switch-socket element Door width: 238 mm / 412 mm / 238 mm This product contains a light source with energy efficiency class: F	150	920	640	<b>S 2 A 4 4 9 0 0 7</b>			
	incl. handle blocks							
	Additional accessories LED washbasin lighting LED washbasin lighting emotion LED lighting element 934 mm wide in matt chrome LED lighting element 934 mm wide in black matt				PZ 1 0 6 3 90 PZ 1 1 5 0 90 PZ 1 1 4 0 90 PZ 1 1 6 0 90			
	<b>mirror cabinet</b> 3 double mirror doors with 2 side panel lights 9,7 watt each 2 x 910 lumens / 2700 - 6500 Kelvin left and right 2 central partitions, 6 glass shelves 1 LED converter 60 W with sensor for emotion lighting 1 switch-socket element Door width: 388 mm / 412 mm / 388 mm This product contains a light source with energy efficiency class: F	150	1220	640	<b>S 2 A 4 4 1 2 0 7</b>			
	incl. handle blocks							
	Additional accessories LED washbasin lighting LED washbasin lighting emotion LED lighting element 1234 mm wide in matt chrome LED lighting element 1234 mm wide in black matt				PZ 1 0 6 3 12 PZ 1 1 5 0 12 PZ 1 1 4 0 12 PZ 1 1 6 0 12			







You find information on the the washbasin manufacturer at the beginning of the sales book.  
**\*Delivery time: 8 weeks. Price per washbasin. Washbasin without tap hole is incompatible with CLOU System. Please check your order confirmation for correctness.**

# Program 072 - model list

Depth indication corresponds to the carcass depth		Depth in mm	Width in mm	Height in mm	Article number	Hinge
<b>Mirror cabinets</b>						
	<p><b>mirror cabinet</b> 3 double mirror doors with 2 side panel lights 9,7 watt each 2 x 910 lumens / 2700 - 6500 Kelvin left and right 2 central partitions, 6 glass shelves 1 LED converter 60 W with sensor for emotion lighting 1 switch-socket element Door width: 546 mm / 296 mm / 546 mm This product contains a light source with energy efficiency class: F</p> <p>Additional accessories LED washbasin lighting LED washbasin lighting emotion LED lighting element 1434 mm wide chrome matt LED lighting element 1434 mm wide in black matt</p>	150	1420	640	<b>S 2 A 4 4 1 4 D 7</b>	
	incl. handle blocks					
					P Z 1 0 6 3 12 P Z 1 1 5 0 12 P Z 1 1 4 0 14 P Z 1 1 6 0 14	
<b>Washbasins</b>						
	<p><b>washbasin 600 mm</b> 1 tap hole incl. CLOU drain and overflow system can be combined with SET 386S 4G</p> <p><b>STONEPLUS - washbasin white</b></p> <p><b>Glass washbasin optiwhite</b></p> <p><b>Glass washbasin optiwhite matt</b></p> <p>Additional accessories Neutrally bonding silicone for glass washbasins Surcharge for washbasins without tap-hole or with 3 holes (according to sketch)</p>	500	632	12	<b>WMS 2 3 0 6 6 1</b> <b>WGS 2 3 0 6 8 2</b> <b>WGS 2 3 0 6 9 2</b>	
					P Z 1 2 3 5	
	<p><b>washbasin 900 mm</b> 1 tap hole incl. CLOU drain and overflow system can be combined with SET 389S 4G</p> <p><b>STONEPLUS - washbasin white</b></p> <p><b>Glass washbasin optiwhite</b></p> <p><b>Glass washbasin optiwhite matt</b></p> <p>Additional accessories Neutrally bonding silicone for glass washbasins Surcharge for washbasins without tap-hole or with 3 holes (according to sketch)</p>	500	932	12	<b>WMS 2 3 0 9 6 1</b> <b>WGS 2 3 0 9 8 2</b> <b>WGS 2 3 0 9 9 2</b>	
					P Z 1 2 3 5	

You find information on the the washbasin manufacturer at the beginning of the sales book.  
**\*Delivery time: 8 weeks. Price per washbasin. Washbasin without tap hole is incompatible with CLOU System. Please check your order confirmation for correctness.**

# Program 072 - model list

Depth indication corresponds to the carcass depth		Depth in mm	Width in mm	Height in mm	Article number	Hinge
<b>Washbasins</b>						
	<b>washbasin 1200 mm</b> 1 tap hole incl. CLOU drain and overflow system can be combined with SET 382S 4G  <b>STONEPLUS - washbasin white</b>  <b>Glass washbasin optiwhite</b>  <b>Glass washbasin optiwhite matt</b>  Additional accessories Neutrally bonding silicone for glass washbasins Surcharge for washbasins without tap-hole or with 3 holes (according to sketch)	500	1232	12	<b>W M S 2 3 1 2 6 1</b>	
		500	1232	12	<b>W G S 2 3 1 2 8 2</b>	
		500	1232	12	<b>W G S 2 3 1 2 9 2</b>	
					P Z 1 2 3 5	
	<b>Double washbasin 1400 mm</b> 2 tap holes incl. 2 CLOU drain and overflow systems can be combined with SET 384S 4G  <b>STONEPLUS - washbasin white</b>  <b>Glass washbasin optiwhite</b>  <b>Glass washbasin optiwhite matt</b>  Additional accessories Neutrally bonding silicone for glass washbasins Surcharge for washbasins without tap-hole or with 3 holes (according to sketch)	500	1432	12	<b>W M S 2 3 4 D 6 1</b>	
		500	1432	12	<b>W G S 2 3 4 D 8 2</b>	
		500	1432	12	<b>W G S 2 3 4 D 9 2</b>	
					P Z 1 2 3 5	
<b>Washbasin base units</b>						
	<b>Washbasin base unit</b> 1 metal pull out unit with buffered closing 1 metal pull-out with buffered closing side doubling 10 mm each  Additional accessories  Space-saving drain stench trap DN 40 Space-saving drain stench trap DN 32	492	620	480	<b>S E T 3 8 6 S 4 G</b>	
					P Z 1 3 6 7	
					P Z 1 4 2 3	
	<b>Washbasin base unit</b> 1 metal pull out unit with buffered closing 1 metal pull-out with buffered closing side doubling 10 mm each  Additional accessories  Space-saving drain stench trap DN 40 Space-saving drain stench trap DN 32	492	920	480	<b>S E T 3 8 9 S 4 G</b>	
					P Z 1 3 6 7	
					P Z 1 4 2 3	

You find information on the the washbasin manufacturer at the beginning of the sales book.  
**\*Delivery time: 8 weeks. Price per washbasin. Washbasin without tap hole is incompatible with CLOU System. Please check your order confirmation for correctness.**

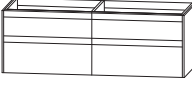
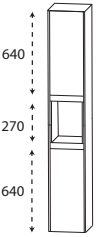
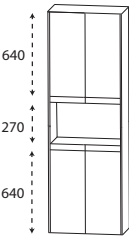

# Program 072 - model list

Depth indication corresponds to the carcass depth		Depth in mm	Width in mm	Height in mm	Article number		Hinge
<b>Washbasin base units</b>							
	<p><b>Washbasin base unit</b>            1 metal pull out unit with buffered closing            1 metal pull-out with buffered closing            side doubling 10 mm each</p> <p>Additional accessories</p> <p>Space-saving drain stench trap DN 40            Space-saving drain stench trap DN 32</p>	492	1220	480	<b>S E T 3 8 2 S 4 G</b>		
	<p><b>Washbasin base unit</b>            2 Washbasin base units (700 mm + 700 mm), je:            1 metal pull out unit with buffered closing            1 metal pull-out with buffered closing            side doubling 10 mm each</p> <p>Additional accessories</p> <p>Space-saving drain stench trap DN 40 (order 2 pieces)            Space-saving drain stench trap DN 32 (order 2 pieces)</p>	492	1420	480	<b>S E T 3 8 4 S 4 G</b>		
<b>Tall units</b>							
	<p><b>Tall unit</b>            2 doors            1 glass shelf (top)            1 glass shelf            1 open compartment            side doubling 10 mm each</p>	322	320	1630	<b>H N A 0 2 3 D 0 3</b>	L/R	
		322	420	1630	<b>H N A 0 2 4 D 0 3</b>	L/R	
	<p><b>Tall unit</b>            4 doors            1 glass shelf (top)            1 glass shelf            1 open compartment            side doubling 10 mm each</p>	322	620	1630	<b>H N A 0 2 6 D 0 3</b>		

Please observe suitable accessories in the separate index.

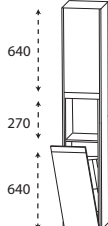

# Program 072 - model list

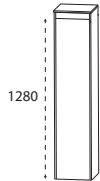
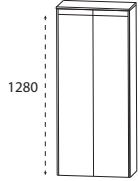
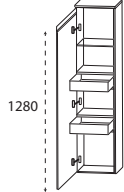
Depth indication corresponds to the carcass depth		Depth in mm	Width in mm	Height in mm	Article number	Hinge
<b>Tall units</b>						
	<b>Tall unit</b> 1 door 1 glass shelf (top) 1 open compartment 1 laundry basket with wire basket side doubling 10 mm each  Volume of laundry basket: 25 liters	322	320	1630	<b>HNA023D3W</b>	L/R
	Volume of laundry basket: 35 liters	322	420	1630	<b>HNA024D3W</b>	L/R
	<b>Tall unit</b> 2 doors 1 glass shelf (top) 1 open compartment 1 laundry basket with wire basket Volume of laundry basket: 55 liters side doubling 10 mm each	322	620	1630	<b>HNA026D3W</b>	
<b>Central units</b>						
	<b>medium-high unit</b> 1 door 4 glass shelves side doubling 10 mm each 1 top cover 325 mm deep	325	325	1330	<b>MNA813D03</b>	L/R
		325	425	1330	<b>MNA814D03</b>	L/R
	<b>medium-high unit</b> 2 doors 4 glass shelves side doubling 10 mm each 1 top cover 325 mm deep	325	625	1330	<b>MNA816D03</b>	
	<b>medium-high unit with inside drawers</b> 1 door 1 glass shelf (top) 2 inside drawers with buffered closing side doubling 10 mm each 1 top cover 325 mm deep	325	325	1330	<b>MNA843D03</b>	L/R
		325	425	1330	<b>MNA844D03</b>	L/R



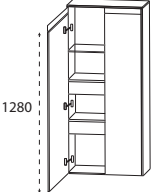
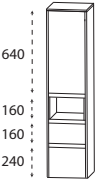
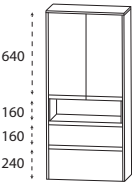
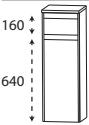
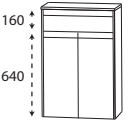
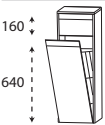

Please observe suitable accessories in the separate index.

# Program 072 - model list

Depth indication corresponds to the carcass depth		Depth in mm	Width in mm	Height in mm	Article number	Hinge
<b>Central units</b>						
	<b>medium-high unit with inside drawers</b> 2 doors 1 continuous glass shelf 2 continuously inside metal-drawer with buffered closing side doubling 10 mm each 1 top cover 325 mm deep	325	625	1330	<b>M N A 8 4 6 D 0 3</b>	
	<b>medium-high unit</b> 1 door 1 glass shelf 1 open compartment 1 drawer with buffered closing 1 metal pull-out with buffered closing incl. drawer rail side doubling 10 mm each 1 top cover 325 mm deep	325	325	1330	<b>M N A 8 2 3 D 0 3</b>	L/R
		325	425	1330	<b>M N A 8 2 4 D 0 3</b>	L/R
	<b>medium-high unit</b> 2 doors 1 glass shelf 1 open compartment 1 drawer with buffered closing 1 metal pull-out with buffered closing incl. drawer rail side doubling 10 mm each 1 top cover 325 mm deep	325	625	1330	<b>M N A 8 2 6 D 0 3</b>	
<b>Highboards</b>						
	<b>Highboard</b> 1 drawer with buffered closing 1 door 1 glass shelf side doubling 10 mm each 1 top cover 325 mm deep	325	325	890	<b>H B A 5 5 3 D 0 3</b>	L/R
		325	425	890	<b>H B A 5 5 4 D 0 3</b>	L/R
	<b>Highboard</b> 1 drawer with buffered closing 2 doors 1 glass shelf side doubling 10 mm each 1 top cover 325 mm deep	325	625	890	<b>H B A 5 5 6 D 0 3</b>	
	<b>Highboard with laundry basket</b> 1 drawer with buffered closing 1 laundry basket with wire basket side doubling 10 mm each 1 top cover 325 mm deep					
	Volume of laundry basket: 25 liters	325	325	890	<b>H B A 5 5 3 D 3 W</b>	
Volume of laundry basket: 35 liters	325	425	890	<b>H B A 5 5 4 D 3 W</b>		

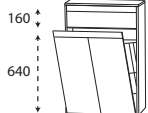
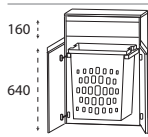
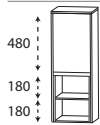
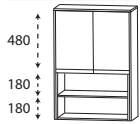

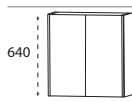

Please observe suitable accessories in the separate index.

# Program 072 - model list

Depth indication corresponds to the carcass depth		Depth in mm	Width in mm	Height in mm	Article number	Hinge
<b>Highboards</b>						
	<p><b>Highboard with laundry basket</b>                      1 drawer with buffered closing                      1 laundry basket with wire basket                      Volume of laundry basket: 55 liters                      side doubling 10 mm each                      1 top cover 325 mm deep</p>	325	625	890	<b>HBA5561DW</b>	
	<p><b>Highboard with laundry pull out</b>                      1 drawer with buffered closing                      1 laundry pull out with wire basket                      Volume of laundry pull out: 40 liters                      side doubling 10 mm each                      1 top cover 325 mm deep</p>	325	625	890	<b>HBA556D3W</b>	
	<p><b>Highboard</b>                      1 door                      1 open compartment                      1 fixed shelf                      in carcass colour                      side doubling 10 mm each                      1 top cover 325 mm deep</p>	325	325	890	<b>HBA513D03</b>	L/R
		325	425	890	<b>HBA514D03</b>	L/R
	<p><b>Highboard</b>                      2 doors                      1 open compartment                      1 fixed shelf                      in carcass colour                      side doubling 10 mm each                      1 top cover 325 mm deep</p>	325	625	890	<b>HBA516D03</b>	
<b>Wall units</b>						
	<p><b>Wall unit</b>                      1 door                      1 glass shelf                      side doubling 10 mm each</p>	172	320	640	<b>OGA413A1G</b>	L/R
		172	320	640	<b>OGA414A1G</b>	L/R
	<p><b>Wall unit</b>                      2 doors                      1 glass shelf                      side doubling 10 mm each</p>	172	620	640	<b>OGA416A1G</b>	
<b>Base units</b>						
	<p><b>Base unit</b>                      1 drawer with buffered closing                      1 metal pull-out with buffered closing                      side doubling 10 mm each                      1 top cover 325 mm deep</p>	325	325	490	<b>UNA383D03</b>	
		325	425	490	<b>UNA384D03</b>	

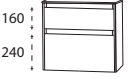

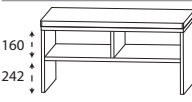

Please observe suitable accessories in the separate index.

# Program 072 - model list

Depth indication corresponds to the carcass depth		Depth in mm	Width in mm	Height in mm	Article number	Hinge
<b>Base units</b>						
	<p><b>Base unit</b>            1 drawer with buffered closing            1 metal pull-out with buffered closing            side doubling 10 mm each            1 top cover 325 mm deep</p>	325	625	490	<b>UNA386D03</b>	
<b>Shelves</b>						
	<p><b>functional shelf</b>            Edges are cut with a mitre            vertical and horizontal mounting possible</p> <p>please indicate colour version:            no. 501 white matt lacquered            no. 547 black matt lacquered</p>	150	300	160	<b>RGL113001</b>	
	<p><b>functional shelf</b>            Edges are cut with a mitre            vertical and horizontal mounting possible</p> <p>please indicate colour version:            no. 501 white matt lacquered            no. 547 black matt lacquered</p>	150	600	160	<b>RGL116002</b>	
	<p><b>functional shelf</b>            Edges are cut with a mitre            vertical and horizontal mounting possible</p> <p>please indicate colour version:            no. 501 white matt lacquered            no. 547 black matt lacquered</p>	150	900	160	<b>RGL119003</b>	
<b>Benches</b>						
	<p><b>Bench</b>            1 shelf            1 seat cushion in imitation leather            Colour version corresponds to the carcass colour</p> <p>cushion in creamy-white</p> <p>cushion in black</p>	450	600	508	<b>SETBANK6W</b>	
		450	600	508	<b>SETBANK6S</b>	
	<p><b>Bench</b>            2 shelves            1 seat cushion in imitation leather            Colour version corresponds to the carcass colour</p> <p>cushion in creamy-white</p> <p>cushion in black</p>	450	900	508	<b>SETBANK9W</b>	
		450	900	508	<b>SETBANK9S</b>	

Please observe suitable accessories in the separate index.

## Program 072 - model list

Depth indication corresponds to the carcass depth		Depth in mm	Width in mm	Height in mm	Article number			Hinge
<b>Glass shelves</b>								
	<b>Glass shelf</b> incl. metal holder							
	<b>400 mm wide</b> incl. 2 metal brackets	130	400	8	<b>A B G 1 3 4 0 0 8</b>			
	<b>600 mm wide</b> incl. 2 metal brackets	130	600	8	<b>A B G 1 3 6 0 0 8</b>			
	<b>900 mm wide</b> incl. 3 metal brackets	130	900	8	<b>A B G 1 3 9 0 0 8</b>			
	<b>1200 mm wide</b> incl. 3 metal brackets	130	1200	8	<b>A B G 1 3 1 2 0 8</b>			
	<b>1400 mm wide</b> incl. 4 metal brackets	130	1400	8	<b>A B G 1 3 1 4 0 8</b>			
<b>Push- fit shelf</b>								
	<b>Push-fit shelf</b> with ABS thick edge all around incl. holders for push fit shelf							
	<b>300 mm wide</b> incl. 2 push-fit holder	150	300	28	<b>S B G 6 0 3 0</b>			
	<b>400 mm wide</b> incl. 2 push-fit holder	150	400	28	<b>S B G 6 0 4 0</b>			
	<b>600 mm wide</b> incl. 2 push-fit holder	150	600	28	<b>S B G 6 0 6 0</b>			
	<b>900 mm wide</b> incl. 3 push-fit holder	150	900	28	<b>S B G 6 0 9 0</b>			
	<b>1200 mm wide</b> incl. 3 push-fit holder	150	1200	28	<b>S B G 6 0 1 2</b>			
	<b>1400 mm wide</b> incl. 3 push-fit holder	150	1400	28	<b>S B G 6 0 1 4</b>			
<b>Accessories</b>								
	<b>LED lighting element in chrome matt</b> This product contains a light source with energy efficiency class: G							
	634 mm wide 9,28 watt / 731 lumens / (2700 -) 6500 Kelvin	127	634	24	<b>P Z 1 1 4 0 6 0</b>			
	934 mm wide 14,08 Watt / 1109 lumens / (2700 -) 6500 Kelvin	127	934	24	<b>P Z 1 1 4 0 9 0</b>			
	1234 mm wide 18,88 watt / 1487 lumens / (2700 -) 6500 Kelvin	127	1234	24	<b>P Z 1 1 4 0 1 2</b>			
	1434 mm wide 23,18 watt / 1739 lumens / (2700 -) 6500 Kelvin	127	1434	24	<b>P Z 1 1 4 0 1 4</b>			

Please observe suitable accessories in the separate index.

# Program 072 - model list

Depth indication corresponds to the carcass depth

## Accessories

	Depth in mm	Width in mm	Height in mm	Article number		Hinge
 <p><b>LED lighting element in black matt</b> This product contains a light source with energy efficiency class: G</p> <p>634 mm wide 9,28 watt / 731 lumens / (2700 -) 6500 Kelvin</p> <p>934 mm wide 14,08 Watt / 1109 lumens / (2700 -) 6500 Kelvin</p> <p>1234 mm wide 18,88 watt / 1487 lumens / (2700 -) 6500 Kelvin</p> <p>1434 mm wide 23,18 watt / 1739 lumens / (2700 -) 6500 Kelvin</p>	127	634	24	<b>P Z</b>	<b>1 1 6 0 6 0</b>	
	127	934	24	<b>P Z</b>	<b>1 1 6 0 9 0</b>	
	127	1234	24	<b>P Z</b>	<b>1 1 6 0 1 2</b>	
	127	1434	24	<b>P Z</b>	<b>1 1 6 0 1 4</b>	

Please observe suitable accessories in the separate index.

## Program 072 - bathroom variations

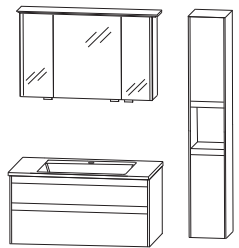
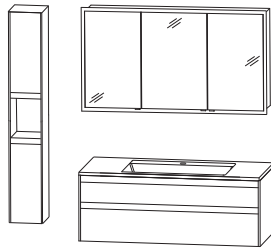
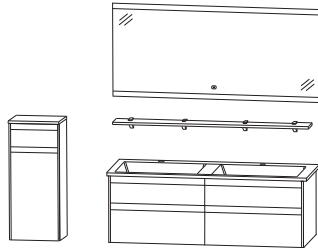
<b>NXG-9290-1</b>		
1 mirror cabinet	S 2 A 4 4 9 0 0 7	
1 LED lighting element	P Z 1 1 6 0 9 0	
1 Glass washbasin optiwhite matt	W G S 2 3 0 9 9 2	
1 Washbasin base unit	S E T 3 8 9 S 4 G	
1 Tall unit Door handing right	H N A 0 2 3 D 0 3	
		932 mm wide
<b>NXG-8212-1</b>		
1 Built-in mirrored cabinet	S 2 A 5 3 1 2 E 1	
1 Glass washbasin optiwhite	W G S 2 3 1 2 8 2	
1 Washbasin base unit	S E T 3 8 2 S 4 G	
1 Tall unit Door handing left	H N A 0 2 3 D 0 3	
		1232 mm wide
<b>NXS-6114-1</b>		
1 Mirror	F S B 4 3 1 4 0 1	
1 Glass shelf	A B G 1 3 1 4 0 8	
1 STONEPLUS - washbasin white	W M S 2 3 4 D 6 1	
1 Washbasin base unit	S E T 3 8 4 S 4 G	
1 Highboard Door handing left	H B A 5 5 4 D 0 3	
		1432 mm wide

# Program 072 - dimensional drawings

WMS/WGS 2306 + SET 386S 4G

WMS/WGS 2309 + SET 389S 4G

WMS/WGS 2312 + SET 382S 4G

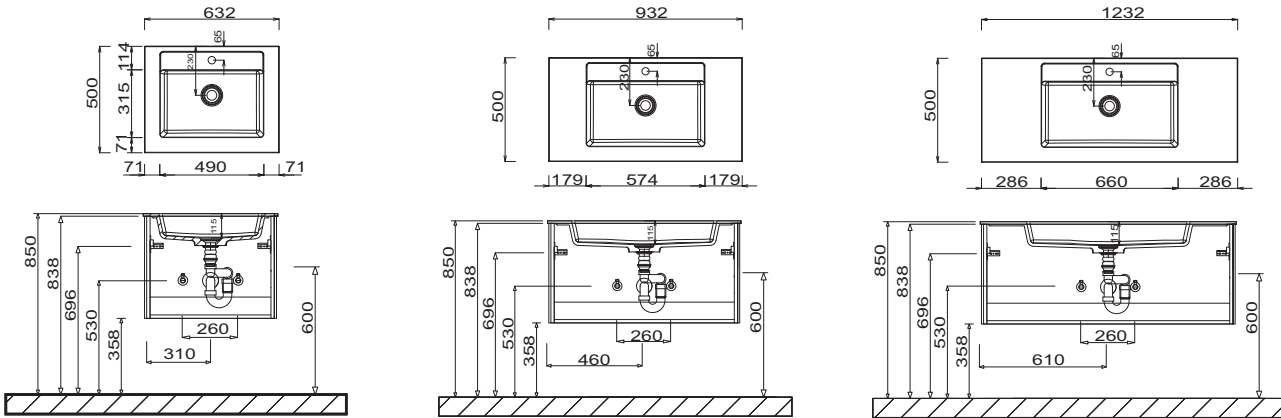

WMS/WGS 234D + SET 384S 4G

electrical connections for mirror cabinets

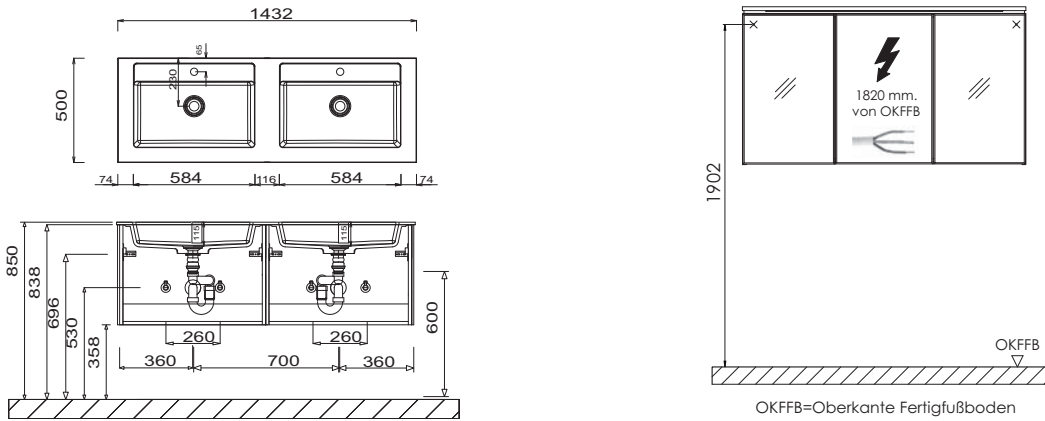

S2A 53xx E1, S2A 55xx E1

Wall cutout for built-in mirrored cabinets

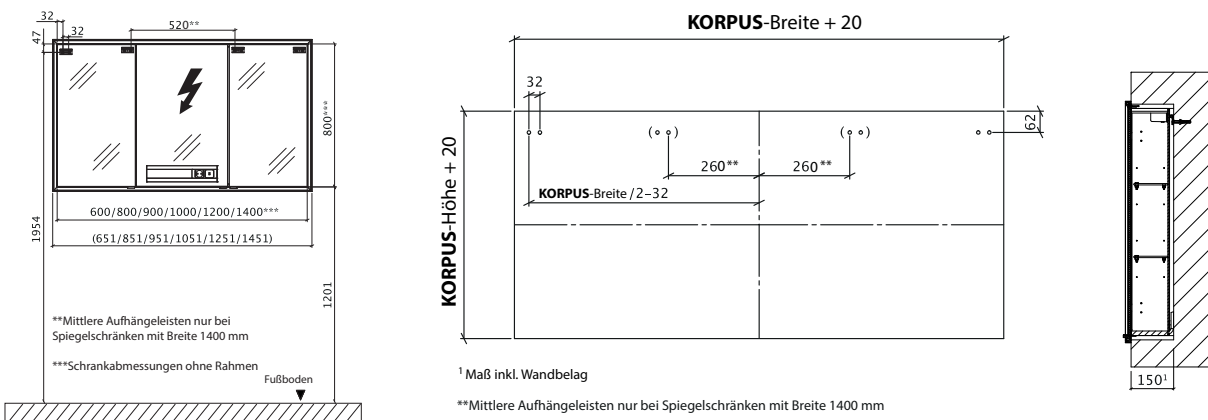

STONEPLUS:

The water temperature must not exceed 55° C / 131° F. Hair tinting lotions have to be removed in a few seconds, so that staining can be avoided.

Modifications:

Technical modifications (+/- 5mm) and flatness modifications (DIN 18202) are subject of the usual material-specific modifications for construction materials, based on DIN 18202.