



### Front colours



no. 794 sand oak



No. 894 glass Optiwhite matt  
outer edges in sand oak



No. 895 glass grey matt  
outer edges in sand oak

**F** foiled front

**G** glass front

### carcass colours



Carrier material in  
no. 194  
sand oak

Visible side  
colours  
No. 307 glass  
Optiwhite matt



Carrier material in  
no. 194  
sand oak

Visible side colours  
No. 310 glass  
grey matt

### Handle and technique versions



Push to open

No. 558  
Premium - Push to open Silent  
No. 005



No. 329  
Strip handle chrome



no. 338  
Strip handle aluminium  
matt



No. 339  
Strip handle black matt

### Washbasin colours

#### STONEPLUS washbasins



No. 61  
white **STONEPLUS**

New, harder, easy-care  
surface.

#### Glass washbasin



no. 82  
optiwhite



no. 92  
optiwhite matt

No. 554  
Pull out with premium soft  
close











No. 003  
door with integrated buffered  
closing

handle length 294 mm / 494  
mm

Illustrations and specifications are without obligation. Technical modifications reserved.  
2022/2023



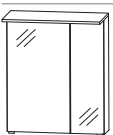



Please note the instruction for warranty, mounting and care, and the quality agreements as well, at the beginning of the book.

# Program 056 - type list

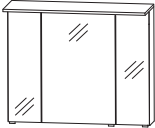
Depth indication corresponds to the carcass depth		Depth in mm	Width in mm	Height in mm	Article number	Hinge
<b>Mirrors</b>						
  	<p><b>mirror, 600 mm</b> LED- lighting (18,6 W.) 1525 lumens / 2700 - 6500 Kelvin at top and bottom with mirror heating 15 watt inkl. converter 60 Watt / 24 V. Emotion lighting 1 sensor for mirror heating This product contains a light source with energy efficiency class: F</p>	33	600	672	<b>F S A 4 3 6 0 8 9</b>	
  	<p><b>Mirror, 900 mm</b> LED- lighting (27,9 W.) 2288 lumens / 2700 - 6500 Kelvin at top and bottom with mirror heating 15 watt inkl. converter 60 Watt / 24 V. Emotion lighting 1 sensor for mirror heating This product contains a light source with energy efficiency class: F</p>	33	900	672	<b>F S A 4 3 9 0 8 9</b>	
  	<p><b>Mirror, 1200 mm</b> LED- lighting (37,2 W.) 3050 lumens / 2700 - 6500 Kelvin at top and bottom with mirror heating 15 watt inkl. converter 60 Watt / 24 V. Emotion lighting This product contains a light source with energy efficiency class: F 1 sensor for mirror heating</p>	33	1200	672	<b>F S A 4 3 1 2 8 9</b>	
<b>Mirror cabinets</b>						
  	<p><b>Mirror cabinet, 600 mm</b> 2 mirror doors on wooden-plated 1 central partition 4 glass shelves 1 LED panel light (8,5 watt) 697 lumens / 2700 - 6500 Kelvin 1 LED converter 12 V, 15 watt large door with mirror heating 15 watt inkl. converter 15 Watt / 24 V. Emotion lighting 1 switch socket element Door width: 396 mm / 196 mm This product contains a light source with energy efficiency class: F</p>	150	600	650	<b>S 2 A 4 3 6 L 8 9</b>	
	<p><b>Mirror cabinet, 600 mm</b> Description as above, though without mirror heating and converter 24 volt</p> <p>Additional accessories LED washbasin lighting LED washbasin lighting emotion</p>	150	600	650	<b>S 2 A 4 3 6 L 9 1</b>	
					P Z 1 0 6 3 6 0 P Z 1 1 5 0 6 0	

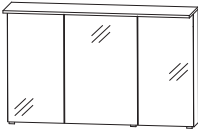



Please observe suitable accessories in the separate index.

# Program 056 - type list

		Depth in mm	Width in mm	Height in mm	Article number	Hinge
Depth indication corresponds to the carcass depth						
<b>Mirror cabinets</b>						
  	<p><b>Mirror cabinet, 900 mm</b>            3 mirror doors on wooden-plated            6 glass shelves            2 central partitions,            1 LED panel light (13,2 watt)            1082 lumens / 2700 - 6500 Kelvin            1 LED converter 12 V, 30 watt            central door with mirror heating 15 watt            inkl. converter 15 Watt / 24 V.            Emotion lighting            1 switch socket element            Door width: 238 mm / 412 mm / 238 mm            This product contains a light source with energy efficiency class: F</p>	150	900	650	<b>S 2 A 4 3 9 A 8 9</b>	
	<p><b>Mirror cabinet, 900 mm</b>            Description as above, though            without mirror heating and converter 24 volt</p> <p>Additional accessories            LED washbasin lighting            LED washbasin lighting emotion</p>	150	900	650	<b>S 2 A 4 3 9 A 9 1</b>  P Z 1 0 6 3 90 P Z 1 1 5 0 90	
  	<p><b>Mirror cabinet, 1200 mm</b>            3 mirror doors on wooden-plated            2 central partitions,            6 glass shelves            1 LED panel light (17,8 watt)            1460 lumens / 2700 - 6500 Kelvin            1 LED converter 12 V, 30 watt            central door with mirror heating 15 watt            inkl. converter 15 Watt / 24 V.            Emotion lighting            1 switch socket element            Door width: 388 mm / 412 mm / 388 mm            This product contains a light source with energy efficiency class: F</p>	150	1200	650	<b>S 2 A 4 3 1 A 8 9</b>	
	<p><b>Mirror cabinet, 1200 mm</b>            Description as above, though            without mirror heating and converter 24 volt</p> <p>Additional accessories            LED washbasin lighting            LED washbasin lighting emotion</p>	150	1200	650	<b>S 2 A 4 3 1 A 9 1</b>  P Z 1 0 6 3 12 P Z 1 1 5 0 12	
<b>STONEPLUS washbasins</b>						
	<p><b>STONEPLUS washbasin, 600 mm</b>            colour white            inkl. concealed overflow system chrome finish</p> <p>can be combined with WUA 3360 23, WUA 3360 30</p> <p>Additional accessories            Additional price for Washbasin without tap hole / with 3 holes            (acc. to sketch).</p>	500	620	15	<b>W M S 5 0 6 0 6 1</b>	







You find information on the the washbasin manufacturer at the beginning of the sales book.  
**\*Delivery time: 8 weeks. Price per washbasin. Washbasin without tap hole is incompatible with CLOU System. Please check your order confirmation for correctness.**

# Program 056 - type list

Depth indication corresponds to the carcass depth		Depth in mm	Width in mm	Height in mm	Article number			Hinge
<b>STONEPLUS washbasins</b>								
	<b>STONEPLUS washbasin, 900 mm</b> colour white inkl. concealed overflow system chrome finish  can be combined with WUA 3390 23, WUA 3390 30  Additional accessories Additional price for Washbasin without tap hole / with 3 holes (acc. to sketch).	500	920	15	<b>WMS</b>	<b>5 0 9 0 6 1</b>		
	<b>STONEPLUS washbasin, 1.200 mm</b> colour white inkl. concealed overflow system chrome finish  can be combined with WUA 3312 23, WUA 3312 30  Additional accessories Additional price for Washbasin without tap hole / with 3 holes (acc. to sketch).	500	1220	15	<b>WMS</b>	<b>5 1 2 0 6 1</b>		
	<b>STONEPLUS double washbasin, 1200 mm,</b> colour white inkl. 2 concealed overflow systems chrome finish  can be combined with WUA 332D 23, WUA 332D 30  Additional accessories Additional price for Washbasin without tap hole / with 3 holes (acc. to sketch).	500	1220	15	<b>WMS</b>	<b>7 1 2 0 6 1</b>		
<b>Glass washbasin</b>								
	<b>Glass washbasin, 600 mm</b> inkl. concealed overflow system chrome finish  <b>Colour Optiwhite</b> <b>Colour Optiwhite matt</b>  can be combined with WUA 3360 23, WUA 3360 30  Additional accessories Neutrally bonding silicone for glass washbasins Surcharge for washbasins without tap-hole or with 3 holes (according to sketch)	500 500	620 620	12 12	<b>SWG</b> <b>SWG</b>	<b>5 0 6 0 8 2</b> <b>5 0 6 0 9 2</b>	P Z	1 2 3 5
	<b>Glass washbasin, 900 mm</b> inkl. concealed overflow system chrome finish  <b>Colour Optiwhite</b> <b>Colour Optiwhite matt</b>  can be combined with WUA 3390 23, WUA 3390 30  Additional accessories Neutrally bonding silicone for glass washbasins Surcharge for washbasins without tap-hole or with 3 holes (according to sketch)	500 500	920 920	12 12	<b>SWG</b> <b>SWG</b>	<b>5 0 9 0 8 2</b> <b>5 0 9 0 9 2</b>	P Z	1 2 3 5

You find information on the the washbasin manufacturer at the beginning of the sales book.  
**\*Delivery time: 8 weeks. Price per washbasin. Washbasin without tap hole is incompatible with CLOU System. Please check your order confirmation for correctness.**

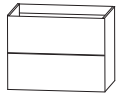

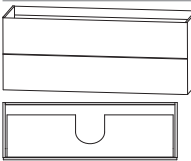

# Program 056 - type list

Depth indication corresponds to the carcass depth		Depth in mm	Width in mm	Height in mm	Article number	Hinge
<b>Glass washbasin</b>						
	<b>Glass washbasin, 1200 mm</b> inkl. concealed overflow system chrome finish					
	<b>Colour Optiwhite</b>	500	1220	12	<b>SWG 5 1 2 0 8 2</b>	
	<b>Colour Optiwhite matt</b>	500	1220	12	<b>SWG 5 1 2 0 9 2</b>	
	can be combined with WUA 3312 23, WUA 3312 30					
	Additional accessories Neutrally bonding silicone for glass washbasins Surcharge for washbasins without tap-hole or with 3 holes (according to sketch)				P Z 1 2 3 5	
	<b>Glass double washbasin, 1200 mm</b> inkl. 2 concealed overflow systems chrome finish					
	<b>Colour Optiwhite</b>	500	1220	12	<b>SWG 7 1 2 0 8 2</b>	
	<b>Colour Optiwhite matt</b>	500	1220	12	<b>SWG 7 1 2 0 9 2</b>	
	can be combined with WUA 332D 23, WUA 332D 30					
	Additional accessories Neutrally bonding silicone for glass washbasins Surcharge for washbasins without tap-hole or with 3 holes (according to sketch)				P Z 1 2 3 5	
<b>Washbasin base units handleless / Push to open</b>						
	<b>Washbasin base unit 600 mm</b> 1 metal pull out unit with buffered closing 1 metal pull-out with buffered closing incl. drawer rail	470	600	480	<b>WUA 3 3 6 0 2 3</b>	
	Additional accessories Space-saving drain stench trap DN 40 Space-saving drain stench trap DN 32				P Z 1 3 6 7 P Z 1 4 2 3	
	<b>washbasin base unit 900 mm</b> 1 metal pull out unit with buffered closing 1 metal pull-out with buffered closing incl. drawer rail	470	900	480	<b>WUA 3 3 9 0 2 3</b>	
	Additional accessories Space-saving drain stench trap DN 40 Space-saving drain stench trap DN 32				P Z 1 3 6 7 P Z 1 4 2 3	
	<b>washbasin base unit 1200 mm for single washbasin solution</b> 1 metal pull out unit with buffered closing 1 metal pull-out with buffered closing incl. drawer rail	470	1200	480	<b>WUA 3 3 1 2 2 3</b>	
	Additional accessories Space-saving drain stench trap DN 40 Space-saving drain stench trap DN 32				P Z 1 3 6 7 P Z 1 4 2 3	

You find information on the the washbasin manufacturer at the beginning of the sales book.

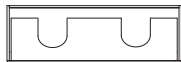
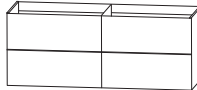
**\*Delivery time: 8 weeks. Price per washbasin. Washbasin without tap hole is incompatible with CLOU System. Please check your order confirmation for correctness.**

# Program 056 - type list

Depth indication corresponds to the carcass depth	Depth in mm	Width in mm	Height in mm	Article number	Hinge
<h3>Washbasin base units handleless / Push to open</h3>					
 <p><b>washbasin base unit 1200 mm for double washbasin solutions</b>            1 metal pull out unit with buffered closing            1 metal pull-out with buffered closing incl. drawer rail</p>  <p>Additional accessories            Space-saving drain stench trap DN 40 (order 2 pieces)            Space-saving drain stench trap DN 32 (order 2 pieces)</p>	470	1200	480	<b>W U A 3 3 2 D 2 4</b>  P Z 1 3 6 7 P Z 1 4 2 3	
 <p><b>washbasin base unit 1200 mm for double washbasin solutions</b>            2 metal pull out units with buffered closing and syphon cut-out            2 metal pull outs with buffered closing and rail</p> <p>Additional accessories            Space-saving drain stench trap DN 40 (order 2 pieces)            Space-saving drain stench trap DN 32 (order 2 pieces)</p>	470	1200	480	<b>W U A 3 3 2 D 2 3</b>  P Z 1 3 6 7 P Z 1 4 2 3	
<h3>Washbasin base units with handles / without Push to open</h3>					
 <p><b>Washbasin base unit 600 mm</b>            1 metal pull out unit with buffered closing            1 metal pull-out with buffered closing incl. drawer rail</p> <p>Additional accessories            Space-saving drain stench trap DN 40            Space-saving drain stench trap DN 32</p>	470	600	480	<b>W U A 3 3 6 0 3 0</b>  P Z 1 3 6 7 P Z 1 4 2 3	
 <p><b>washbasin base unit 900 mm</b>            1 metal pull out unit with buffered closing            1 metal pull-out with buffered closing incl. drawer rail</p> <p>Additional accessories            Space-saving drain stench trap DN 40            Space-saving drain stench trap DN 32</p>	470	900	480	<b>W U A 3 3 9 0 3 0</b>  P Z 1 3 6 7 P Z 1 4 2 3	
 <p><b>washbasin base unit 1200 mm for single washbasin solution</b>            1 metal pull out unit with buffered closing            1 metal pull-out with buffered closing incl. drawer rail</p>  <p>Additional accessories            Space-saving drain stench trap DN 40            Space-saving drain stench trap DN 32</p>	470	1200	480	<b>W U A 3 3 1 2 3 0</b>  P Z 1 3 6 7 P Z 1 4 2 3	



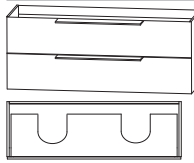
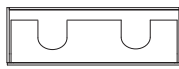
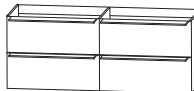
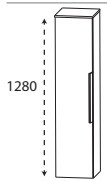
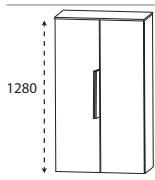
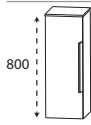

Please observe suitable accessories in the separate index.

# Program 056 - type list

Depth indication corresponds to the carcass depth		Depth in mm	Width in mm	Height in mm	Article number	Hinge
<h3>Washbasin base units with handles / without Push to open</h3>						
	<b>washbasin base unit 1200 mm for double washbasin solutions</b> 1 metal pull out unit with buffered closing 1 metal pull-out with buffered closing incl. drawer rail	470	1200	480	<b>WUA33123D</b>	
	Additional accessories Space-saving drain stench trap DN 40 (order 2 pieces) Space-saving drain stench trap DN 32 (order 2 pieces)				PZ 1367 PZ 1423	
	<b>washbasin base unit 1200 mm for double washbasin solutions</b> 2 metal pull out units with buffered closing and syphon cut-out 2 metal pull outs with buffered closing and rail	470	1200	480	<b>WUA332D30</b>	
	Additional accessories Space-saving drain stench trap DN 40 (order 2 pieces) Space-saving drain stench trap DN 32 (order 2 pieces)				PZ 1367 PZ 1423	
<h3>Central units</h3>						
	<b>medium-high unit</b> 1 door 4 glass shelves 1 glass top cover 326 mm deep	300	308	1286	<b>MNA813A3</b>	L/R
III. with handles						
	<b>medium-high unit</b> 2 doors 4 glass shelves 1 glass top cover 326 mm deep	300	608	1286	<b>MNA816A3</b>	
III. with handles						
<h3>Highboards</h3>						
	<b>Highboard</b> 1 door 2 glass shelves 1 glass top cover 326 mm deep	300	308	806	<b>HBA513A3</b>	L/R
III. with handles						

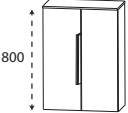
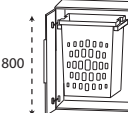
Please observe suitable accessories in the separate index.

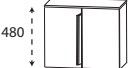

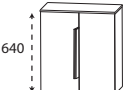

# Program 056 - type list

Depth indication corresponds to the carcass depth		Depth in mm	Width in mm	Height in mm	Article number			Hinge					
<b>Highboards</b>													
 800 III. with handles	<b>Highboard</b> 2 doors 2 glass shelves 1 glass top cover 326 mm deep	300	608	806	H	B	A	5	1	6	A	3	
 800 III. with handles	<b>Highboard with laundry pull out</b> 2 doors 1 laundry pull out Volume of laundry pull out: 40 liters 1 glass top cover 326 mm deep	300	608	806	H	B	A	5	1	6	W	A	3
<b>Base units</b>													
 480 III. with handles	<b>Base unit</b> 1 door 1 glass shelf 1 glass top cover 326 mm deep	300	308	486	U	N	A	3	1	3	A	3	L/R
 480 III. with handles	<b>Base unit</b> 2 doors 1 glass shelf 1 glass top cover 326 mm deep	300	608	486	U	N	A	3	1	6	A	3	
<b>Wall units</b>													
 640 III. with handles	<b>Wall unit</b> 1 door 1 glass shelf 1 glass top cover 176 mm deep	150	308	646	O	G	A	4	1	3	A	3	L/R
 640 III. with handles	<b>Wall unit</b> 2 doors 1 glass shelf 1 glass top cover 176 mm deep	150	608	646	O	G	A	4	1	6	A	3	

Please observe suitable accessories in the separate index.



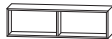



# Program 056 - type list



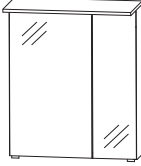

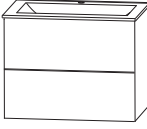
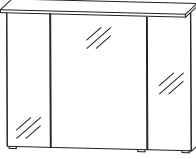
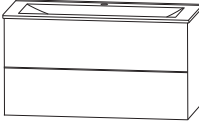
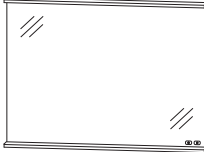

Depth indication corresponds to the carcass depth		Depth in mm	Width in mm	Height in mm	Article number	Hinge
<b>Glass shelves</b>						
	<b>Glass shelf</b> incl. metal holder					
	<b>600 mm wide</b> incl. 2 metal brackets	130	600	8	<b>ABG 1 3 6 0 0 8</b>	
	<b>900 mm wide</b> incl. 3 metal brackets	130	900	8	<b>ABG 1 3 9 0 0 8</b>	
	<b>1200 mm wide</b> incl. 3 metal brackets	130	1200	8	<b>ABG 1 3 1 2 0 8</b>	
<b>Shelves</b>						
	<b>functional shelf</b> Edges are cut with a mitre vertical and horizontal mounting possible	150	300	160	<b>RGL 1 1 3 0 0 1</b>	
	please indicate colour version: no. 501 white matt lacquered no. 547 black matt lacquered					
	<b>functional shelf</b> Edges are cut with a mitre vertical and horizontal mounting possible	150	600	160	<b>RGL 1 1 6 0 0 2</b>	
	please indicate colour version: no. 501 white matt lacquered no. 547 black matt lacquered					
	<b>functional shelf</b> Edges are cut with a mitre vertical and horizontal mounting possible	150	900	160	<b>RGL 1 1 9 0 0 3</b>	
	please indicate colour version: no. 501 white matt lacquered no. 547 black matt lacquered					

Please observe suitable accessories in the separate index.

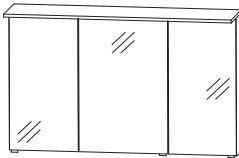
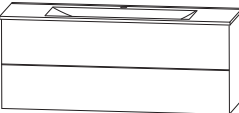
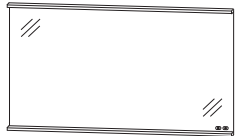
# Program 056 - examples

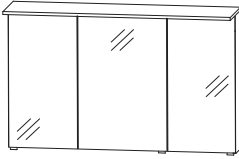
<b>ILS-0160-1</b>				
1	Mirror cabinet, 600 mm	S 2 A 4 3 6 L 8 9		
1	Washbasin base unit	W U A 3 3 6 0 2 3		
1	STONEPLUS washbasin, 600 mm	W M S 5 0 6 0 6 1		
IL G 8 2 6 0 1	SWG 5060 82 glass optiwhite inst. Stoneplus			600 mm wide
IL G 9 2 6 0 1	SWG 5060 92 glass optiwhite matt inst. cast mineral			
<b>ILS-0160-2</b>				
1	Mirror 600 mm	F S A 4 3 6 0 8 9		
1	Washbasin base unit	W U A 3 3 6 0 2 3		
1	STONEPLUS washbasin, 600 mm	W M S 5 0 6 0 6 1		
IL G 8 2 6 0 2	SWG 5060 82 glass optiwhite inst. cast mineral			600 mm wide
IL G 9 2 6 0 2	SWG 5060 92 glass optiwhite matt inst. cast mineral			
<b>ILS-0190-1</b>				
1	Mirror cabinet, 900 mm	S 2 A 4 3 9 A 8 9		
1	Washbasin base unit	W U A 3 3 9 0 2 3		
1	STONEPLUS washbasin, 900 mm	W M S 5 0 9 0 6 1		
IL G 8 2 9 0 1	SWG 5090 82 glass optiwhite inst. cast mineral			900 mm wide
IL G 9 2 9 0 1	SWG 5090 92 glass optiwhite matt inst. cast mineral			
<b>ILS-0190-2</b>				
1	Mirror 900 mm	F S A 4 3 9 0 8 9		
1	Washbasin base unit	W U A 3 3 9 0 2 3		
1	STONEPLUS washbasin, 900 mm	W M S 5 0 9 0 6 1		
IL G 8 2 9 0 2	SWG 5090 82 glass optiwhite inst. cast mineral			900 mm wide
IL G 9 2 9 0 2	SWG 5090 92 glass optiwhite matt inst. cast mineral			

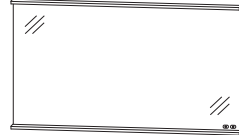
## Program 056 - examples

<b>ILS-0112-1</b>		  1200 mm wide	
1	Mirror cabinet 1200 mm		S 2 A 4 3 1 A 8 9
1	Washbasin base unit		W U A 3 3 1 2 2 3
1	STONEPLUS washbasin, 1.200 mm		W M S 5 1 2 0 6 1
ILG 8 2 1 2 1	SWG 5120 82 glass optiwhite inst. cast mineral		
ILG 9 2 1 2 1	SWG 5120 92 glass optiwhite matt inst. cast mineral		
<b>ILS-0112-2</b>		  1200 mm wide	
1	Mirror 1200 mm		F S A 4 3 1 2 8 9
1	Washbasin base unit		W U A 3 3 1 2 2 3
1	STONEPLUS washbasin, 1.200 mm		W M S 5 1 2 0 6 1
ILG 8 2 1 2 2	SWG 5120 82 glass optiwhite inst. cast mineral		
ILG 9 2 1 2 2	SWG 5120 92 glass optiwhite matt inst. cast mineral		
<b>ILS-0112-1D</b>		  1200 mm wide	
1	Mirror cabinet 1200 mm		S 2 A 4 3 1 A 8 9
1	Washbasin base unit		W U A 3 3 2 D 2 3
1	STONEPLUS washbasin, 1.200 mm Double washbasin		W M S 7 1 2 0 6 1
ILG 8 2 1 2 1 D	SWG 7120 82 glass optiwhite inst. cast mineral		
ILG 9 2 1 2 1 D	SWG 7120 92 glass optiwhite matt inst. cast mineral		
<b>ILS-0112-2D</b>		  1200 mm wide	
1	Mirror 1200 mm		F S A 4 3 1 2 8 9
1	Washbasin base unit		W U A 3 3 2 D 2 3
1	STONEPLUS washbasin, 1.200 mm Double washbasin		W M S 7 1 2 0 6 1
ILG 8 2 1 2 2 D	SWG 7120 82 glass optiwhite inst. cast mineral		
ILG 9 2 1 2 2 D	SWG 7120 92 glass optiwhite matt inst. cast mineral		

# Program 056 - dimensional drawings

WMS / SWG 5060

WMS / SWG 5090

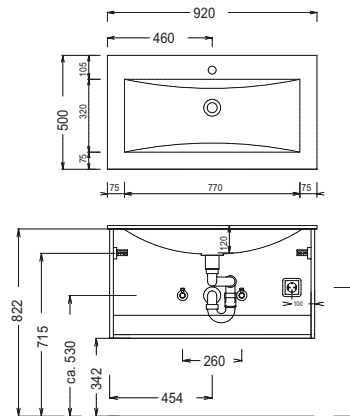
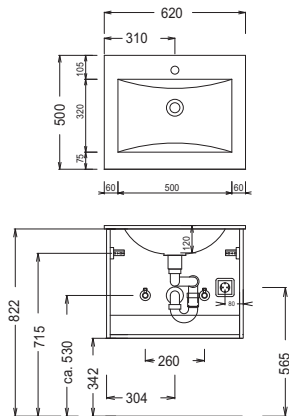

WMS / SWG 5120

WMS / SWG 7120

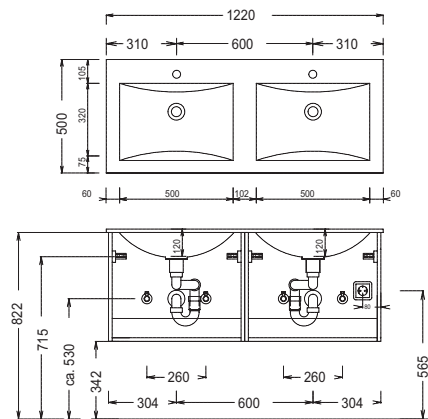
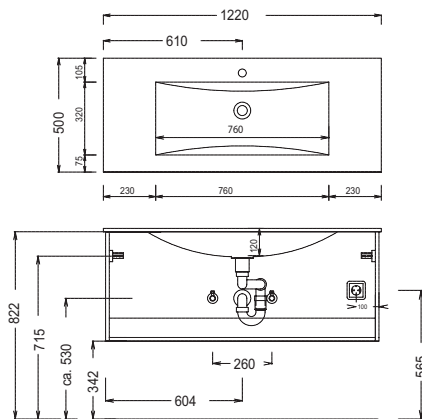

## electrical connections for mirror cabinets

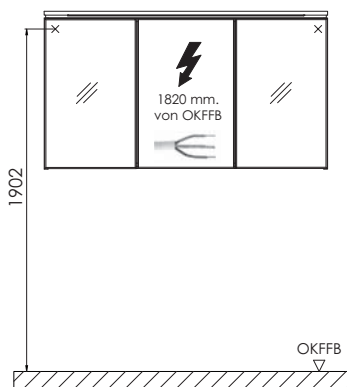

OKFFB=Oberkante Fertigfußboden

### STONEPLUS:

The water temperature must not exceed 55° C / 131° F. Hair tinting lotions have to be removed in a few seconds, so that staining can be avoided.

### Modifications:

Technical modifications (+/- 5mm) and flatness modifications (DIN 18202) are subject of the usual material-specific modifications for construction materials, based on DIN 18202.